

MilesTek

an INFINIT[®] brand



2020 Product Guide

Military & Aerospace Components at the Ready

Same-Day Shipping | +1 (866) 524-1553 | milestek.com

Your Military & Aerospace Interconnect Specialists

Since 1981, MilesTek customers have come to expect more than just products—they expect answers & support that will help them solve all their installation or project questions.

With quick turnaround and same-day shipping for most of the high reliability products we carry, you can rely on MilesTek to help meet your project deadlines.

Markets We Serve:

- Commercial & Military Avionics
- Broadcast & DS3/Telecom
- Military and Industrial Networking
- Aerospace Communications

MilesTek Advantages:

- Large In-Stock Inventories
- Same-Day Shipping
- Prototype Development
- CAD Design Capabilities
- Multiple Testing Solutions
- Expert Technical Support
- ISO 9001:2015 Registered

From high-volume production, to low-volume customized products, MilesTek is your source for military, aerospace, communications and industrial interconnect solutions.



Stocking over 10,000 Products Covering a Wide Breadth of Connectivity Needs:

- Coaxial Cable Assemblies and Harnesses
- Military Avionics/ MIL-STD-1553B
- Bulk Cable by the Foot
- Data Bus Couplers
- Custom Cable Assemblies, Panel Assemblies & Tools
- Twinaxial
- Triaxial
- LSZH Assemblies
- Connectors, Adapters & Terminators
- Switching Devices
- Rugged Ethernet, USB and Fiber Assemblies



Technical Expertise • Customer Service • Unbeatable Value

For Expert Customer Service Call 866-524-1553 • MilesTek.com

TABLE OF CONTENTS

4 - 25 MIL-STD-1553B

NEW PRODUCTS ADDED

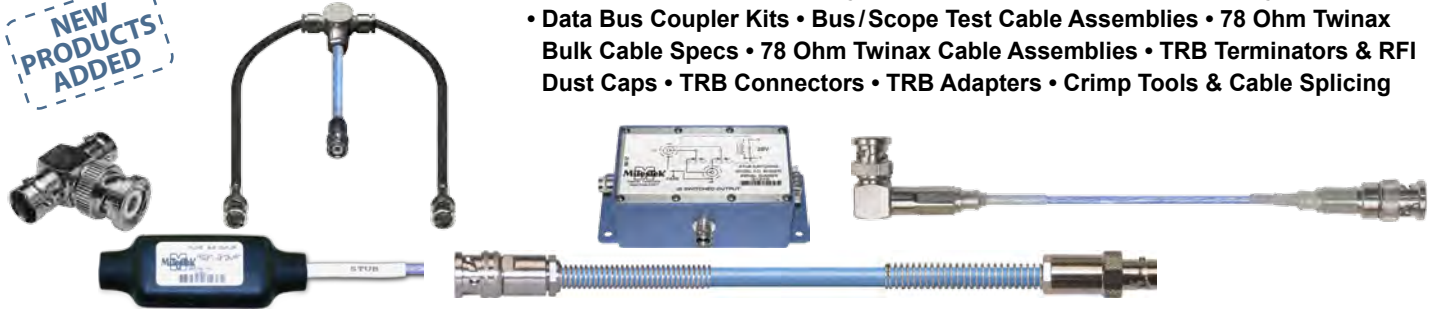

- Data Bus Couplers - Box Style • Data Bus Couplers - Inline • Relay Devices
- Data Bus Coupler Kits • Bus/Scope Test Cable Assemblies • 78 Ohm Twinax Bulk Cable Specs • 78 Ohm Twinax Cable Assemblies • TRB Terminators & RFI Dust Caps • TRB Connectors • TRB Adapters • Crimp Tools & Cable Splicing

26 - 28 SUBMINIATURE

NEW PRODUCTS ADDED



- TRS Data Bus Couplers - Box Style • TRS 78 Ohm Twinax Cable Assemblies
- TRS Subminiature Size Connectors • TRS Crimp Tools and Compatibility Information

29 - 32 TWINAXIAL



- 100 Ohm Twinax Bulk Cable Specs • 100 Ohm Twinax Cable Assemblies • 100 Ohm Bus Terminators • 100 Ohm Twinax Connectors • 124 Ohm Twinax Bulk Cable Specs • 124 Ohm Twinax Cable Assemblies • 124 Ohm Twinax Connectors

34 - 38 TRIAXIAL



- Bulk Cable Specs - 50 & 75 Ohm Triax • 50 Ohm Triax Cable Assemblies
- 50 Ohm Triax Connectors • 75 Ohm Triax Cable Assemblies
- 75 Ohm Triax Connectors

39 D-SUB

NEW PRODUCTS ADDED



- Low Smoke Zero Halogen (LSZH) Cable Assemblies • DB9 - DB25 Male to Female Connectors • Field Termination Connectors

TABLE OF CONTENTS

ETHERNET 40 - 43

- Low Smoke Zero Halogen (LSZH) Assemblies • Category Rated Keystone and Flange Mount Couplers • Industrial Ethernet M12 Assemblies • Industrial GigE Assemblies • IP67 Dual Use Outdoor Ethernet Assemblies • IP68 Ruggedized MIL RJ45 Assemblies and Components



USB 44 - 45

- 2.0 USB • 2.0 USB Waterproof Harsh Environment • 3.0 USB • 3.0 USB Industrial Harsh Environment • LSZH USB Cables • Waterproof USB



SCSI/IEEE-488 GPIB 46

- Low Smoke Zero Halogen (LSZH) Assemblies • Ultra SCSI Cable Assemblies • Premium IEEE-488 Cable Assemblies • Deluxe IEEE-488 Cable Assemblies • Connectors



AUDIO/VIDEO 47 - 49

- High Speed HDMI Cable Assemblies • Premium DVI to HDMI • Mini HDMI • Deluxe DVI-D with Ferrites • LSZH Angled Cable Assemblies



FIBER OPTIC 50 - 51

- Military Cable Assemblies • Multimode IP67 Cable Assemblies • Single mode IP67 Cable Assemblies • IP67 Connectors • Ruggedized IP68 Connectors and Receptacles



PATCH PANELS/POWER CORDS 52 - 63

- Ethernet, USB, D-Sub, HDMI, Fiber Optic Rack Panels • Universal Master Rack Panels • Universal Sub-Panels • Power Cords



MIL-STD-1553B | Data Bus Couplers

1-Stub Data Bus Couplers



90-50201
MSX000001

Part #	1 Piece Price
90-50201	\$188.85
MSX000001	\$180.00 ✓RoHS
Feature	Specification
bus & stub jacks	TRB 3-lug jacks
tech note	non-terminated
bus termination	none



90-50211
MSX000002

Part #	1 Piece Price
90-50211	\$211.68
MSX000002	\$180.00 ✓RoHS
Feature	Specification
bus & stub jacks	TRB 3-lug jacks
tech note	single-terminated
bus termination	none



90-51211
MSX000003

Part #	1 Piece Price
90-51211	\$230.43
MSX000003	\$180.00 ✓RoHS
Feature	Specification
bus & stub jacks	TRB 3-lug jacks
tech note	single-terminated
bus termination	one 78.7 ohm resistor



90-52211
MSX000004

Part #	1 Piece Price
90-52211	\$231.53
MSX000004	\$180.00 ✓RoHS
Feature	Specification
bus & stub jacks	TRB 3-lug jacks
tech note	single-terminated
bus termination	one 78.7 ohm resistor



90-50231
MSX000005

Part #	1 Piece Price
90-50231	\$236.97
MSX000005	\$180.00 ✓RoHS
Feature	Specification
bus & stub jacks	TRB 3-lug jacks
tech note	single-terminated
bus termination	one 78.7 ohm resistor

2-Stub Data Bus Couplers



90-50202
MSX000006

Part #	1 Piece Price
90-50202	\$307.67
MSX000006	\$290.00 ✓RoHS
Feature	Specification
bus & stub jacks	TRB 3-lug jacks
tech note	non-terminated
bus termination	none



90-50212
MSX000007

Part #	1 Piece Price
90-50212	\$320.40
MSX000007	\$290.00 ✓RoHS
Feature	Specification
bus & stub jacks	TRB 3-lug jacks
tech note	single-terminated
bus termination	one 78.7 ohm resistor



90-51212
MSX000008

Part #	1 Piece Price
90-51212	\$352.22
MSX000008	\$290.00 ✓RoHS
Feature	Specification
bus & stub jacks	TRB 3-lug jacks
tech note	single-terminated
bus termination	one 78.7 ohm resistor



90-52212
MSX000009

Part #	1 Piece Price
90-52212	\$352.22
MSX000009	\$290.00 ✓RoHS
Feature	Specification
bus & stub jacks	TRB 3-lug jacks
tech note	single-terminated
bus termination	one 78.7 ohm resistor



90-50222
MSX000010

Part #	1 Piece Price
90-50222	\$425.27
MSX000010	\$290.00 ✓RoHS
Feature	Specification
bus & stub jacks	TRB 3-lug jacks
tech note	dual-terminated
bus termination	two 78.7 ohm resistors

Plenum Cable Assemblies

Item #	Description	1 Pc. Price
MSA00096-12N	Plenum Cable Assembly TRB 3-Slot Plug to Plug MIL-STD-1553 .242" O.D. +125C 78 Ohm Twinaxial Shielded Twisted Pair 1'	\$99.71
MSA00097-12N	Plenum Cable Assembly TRB 3-Slot Plug to Blunt MIL-STD-1553 .242" O.D. +125C 78 Ohm Twinaxial Shielded Twisted Pair 1'	\$88.25
MSA00098-12N	Plenum Cable Assembly TRB 3-Slot Plug to 3-Lug Cable Jack MIL-STD-1553 .242" O.D. +125C 78 Ohm Twinaxial Shielded Twisted Pair 1'	\$104.92
MSA00099-12N	Plenum Cable Assembly TRB 3-Slot Plug to Non-Insulated Bulk Head 3-Lug Cable Jack MIL-STD-1553 .242" O.D. +125C 78 Ohm Twinaxial Shielded Twisted Pair 1'	\$106.33
MSA00100-12N	Plenum Cable Assembly TRB 3-Slot Plug to Insulated Bulk Head 3-Lug Cable Jack MIL-STD-1553 .242" O.D. +125C 78 Ohm Twinaxial Shielded Twisted Pair 1'	\$111.85
MSA00101-12N	Plenum Cable Assembly TRB 3-Slot Plug to Plug with Bend Reliefs MIL-STD-1553 .242" O.D. +125C 78 Ohm Twinaxial Shielded Twisted Pair 1'	\$108.83
MSA00102-12N	Plenum Cable Assembly TRB 3-Slot Plug with Bend Relief to Blunt MIL-STD-1553 .242" O.D. +125C 78 Ohm Twinaxial Shielded Twisted Pair 1'	\$92.78
MSA00103-12N	Plenum Cable Assembly TRB 3-Slot Plug to 3-Lug Cable Jack with Bend Reliefs MIL-STD-1553 .242" O.D. +125C 78 Ohm Twinaxial Shielded Twisted Pair 1'	\$112.32
MSA00104-12N	Plenum Cable Assembly TRB 3-Slot Plug to Non-Insulated Bulk Head 3-Lug Cable Jack with Bend Reliefs MIL-STD-1553 .242" O.D. +125C 78 Ohm Twinaxial Shielded Twisted Pair 1'	\$113.73
MSA00105-12N	Plenum Cable Assembly TRB 3-Slot Plug to Insulated Bulk Head 3-Lug Cable Jack with Bend Reliefs MIL-STD-1553 .242" O.D. +125C 78 Ohm Twinaxial Shielded Twisted Pair 1'	\$119.25
MSA00106-12N	Plenum Cable Assembly TRB 3-Lug Cable Jack to Jack MIL-STD-1553 .242" O.D. +125C 78 Ohm Twinaxial Shielded Twisted Pair 1'	\$108.83
MSA00107-12N	Plenum Cable Assembly TRB Non-Insulated Bulk Head 3-Lug Cable Jack to Jack MIL-STD-1553 .242" O.D. +125C 78 Ohm Twinaxial Shielded Twisted Pair 1'	\$112.95
MSA00108-12N	Plenum Cable Assembly TRB Insulated Bulk Head Jack 3-Lug Cable Jack to Jack MIL-STD-1553 .242" O.D. +125C 78 Ohm Twinaxial Shielded Twisted Pair 1'	\$124.04
MSA00109-12N	Plenum Cable Assembly TRB 3-Lug Cable Jack to Jack with Bend Reliefs MIL-STD-1553 .242" O.D. +125C 78 Ohm Twinaxial Shielded Twisted Pair 1'	\$115.81
MSA00110-12N	Plenum Cable Assembly TRB Non-Insulated Bulk Head 3-Lug Cable Jack to Jack with Bend Reliefs MIL-STD-1553 .242" O.D. +125C 78 Ohm Twinaxial Shielded Twisted Pair 1'	\$113.73
MSA00111-12N	Plenum Cable Assembly TRB Insulated Bulk Head 3-Lug Cable Jack to Jack with Bend Relief MIL-STD-1553 .242" O.D. +125C 78 Ohm Twinaxial Shielded Twisted Pair 1'	\$129.72

Assembly prices shown for 12" length. See our website for additional lengths.



See our website, [MilesTek.com](https://www.milestek.com) to view all of our products.

MilesTek.com | 866-524-1553 | sales@MilesTek.com

MIL-STD-1553B | 3-Stub Data Bus Couplers



**90-50203
MSX000011**



**90-50213
MSX000012**



**90-51213
MSX000013**



**90-52213
MSX000014**



**90-50223
MSX000015**

Part #	1 Piece Price	Feature	Specification
90-50203	\$380.32	bus & stub jacks	TRB 3-lug jacks
MSX000011	\$360.00 ✓RoHS	tech note	non-terminated
		bus termination	none

Part #	1 Piece Price	Feature	Specification
90-50213	\$402.09	bus & stub jacks	TRB 3-lug jacks
MSX000012	\$360.00 ✓RoHS	tech note	single-terminated
		bus termination	one 78.7 ohm resistor

Part #	1 Piece Price	Feature	Specification
90-51213	\$434.97	bus & stub jacks	TRB 3-lug jacks
MSX000013	\$360.00 ✓RoHS	tech note	single-terminated
		bus termination	one 78.7 ohm resistor

Part #	1 Piece Price	Feature	Specification
90-52213	\$439.20	bus & stub jacks	TRB 3-lug jacks
MSX000014	\$360.00 ✓RoHS	tech note	single-terminated
		bus termination	one 78.7 ohm resistor

Part #	1 Piece Price	Feature	Specification
90-50223	\$479.53	bus & stub jacks	TRB 3-lug jacks
MSX000015	\$360.00 ✓RoHS	tech note	dual-terminated
		bus termination	two 78.7 ohm resistors

See our website, MilesTek.com for detailed information.

Halogen Free Cable Assemblies

Item #	Description	1 Pc. Price
MSA00224-12N	Halogen Free Cable Assembly TRB 3-Slot Plug to Plug MIL-STD-1553 .242" O.D. -30C +80C 78 Ohm Twinaxial Shielded Twisted Pair 1'	\$93.68
MSA00225-12N	Halogen Free Cable Assembly TRB 3-Slot Plug to Blunt MIL-STD-1553 .242" O.D. -30C +80C 78 Ohm Twinaxial Shielded Twisted Pair 1'	\$82.22
MSA00226-12N	Halogen Free Cable Assembly TRB 3-Slot Plug to 3-Lug Cable Jack MIL-STD-1553 .242" O.D. -30C +80C 78 Ohm Twinaxial Shielded Twisted Pair 1'	\$98.89
MSA00227-12N	Halogen Free Cable Assembly TRB 3-Slot Plug to Non-Insulated Bulk Head 3-Lug Cable Jack MIL-STD-1553 .242" O.D. -30C +80C 78 Ohm Twinaxial Shielded Twisted Pair 1'	\$100.30

Assembly prices shown for 12" length. See our website for additional lengths.

Custom connectorization and configuration options available.



4-Stub Data Bus Couplers | MIL-STD-1553B

Part #	1 Piece Price	Feature	Specification
90-50204	\$461.22	bus & stub jacks	TRB 3-lug jacks
MSX000016	\$440.00 	tech note	non-terminated
		bus termination	none



90-50204
MSX000016

Part #	1 Piece Price	Feature	Specification
90-50214	\$487.40	bus & stub jacks	TRB 3-lug jacks
MSX000017	\$440.00 	tech note	single-terminated
		bus termination	one 78.7 ohm resistor



90-50214
MSX000017

Part #	1 Piece Price	Feature	Specification
90-51214	\$517.39	bus & stub jacks	TRB 3-lug jacks
MSX000018	\$440.00 	tech note	single-terminated
		bus termination	one 78.7 ohm resistor



90-51214
MSX000018

Part #	1 Piece Price	Feature	Specification
90-52214	\$517.39	bus & stub jacks	TRB 3-lug jacks
MSX000019	\$440.00 	tech note	single-terminated
		bus termination	one 78.7 ohm resistor



90-52214
MSX000019

Part #	1 Piece Price	Feature	Specification
90-50224	\$576.31	bus & stub jacks	TRB 3-lug jacks
MSX000020	\$440.00 	tech note	dual-terminated
		bus termination	two 78.7 ohm resistors



90-50224
MSX000020

See our website, MilesTek.com for detailed information.

Halogen Free Cable Assemblies

Item #	Description	1 Pc. Price
MSA00228-12N	Halogen Free Cable Assembly TRB 3-Slot Plug to Insulated Bulk Head 3-Lug Cable Jack MIL-STD-1553 .242" O.D. -30C +80C 78 Ohm Twinaxial Shielded Twisted Pair 1'	\$105.92
MSA00234-12N	Halogen Free Cable Assembly TRB 3-Lug Cable Jack to Jack MIL-STD-1553 .242" O.D. -30C +80C 78 Ohm Twinaxial Shielded Twisted Pair 1'	\$104.10
MSA00229-12N	Halogen Free Cable Assembly TRB 3-Slot Plug to Plug with Bend Reliefs MIL-STD-1553 .242" O.D. -30C +80C 78 Ohm Twinaxial Shielded Twisted Pair 1'	\$102.80
MSA00230-12N	Halogen Free Cable Assembly TRB 3-Slot Plug with Bend Relief to Blunt MIL-STD-1553 .242" O.D. -30C +80C 78 Ohm Twinaxial Shielded Twisted Pair 1'	\$86.91

Assembly prices shown for 12" length. See our website for additional lengths.



Custom connectorization and configuration options available.

MIL-STD-1553B | 5-Stub Data Bus Couplers



**90-50205
MSX000021**



**90-50215
MSX000022**



**90-51215
MSX000023**



**90-52215
MSX000024**



**90-50225
MSX000025**

Part #	1 Piece Price	Feature	Specification
90-50205	\$542.05	bus & stub jacks	TRB 3-lug jacks
MSX000021	\$540.00 ✓RoHS	tech note	non-terminated
		bus termination	none

Part #	1 Piece Price	Feature	Specification
90-50215	\$589.48	bus & stub jacks	TRB 3-lug jacks
MSX000022	\$540.00 ✓RoHS	tech note	single-terminated
		bus termination	one 78.7 ohm resistor

Part #	1 Piece Price	Feature	Specification
90-51215	\$617.60	bus & stub jacks	TRB 3-lug jacks
MSX000023	\$540.00 ✓RoHS	tech note	single-terminated
		bus termination	one 78.7 ohm resistor

Part #	1 Piece Price	Feature	Specification
90-52215	\$610.59	bus & stub jacks	TRB 3-lug jacks
MSX000024	\$540.00 ✓RoHS	tech note	single-terminated
		bus termination	one 78.7 ohm resistor

Part #	1 Piece Price	Feature	Specification
90-50225	\$662.01	bus & stub jacks	TRB 3-lug jacks
MSX000025	\$540.00 ✓RoHS	tech note	dual-terminated
		bus termination	two 78.7 ohm resistors

Halogen Free Cable Assemblies

Item #	Description	1 Pc. Price
MSA00231-12N	Halogen Free Cable Assembly TRB 3-Slot Plug to 3-Lug Cable Jack with Bend Reliefs MIL-STD-1553 .242" O.D. -30C +80C 78 Ohm Twinaxial Shielded twisted pair 1'	\$103.84
MSA00232-12N	Halogen Free Cable Assembly TRB 3-Slot Plug to Non-Insulated Bulk Head 3-Lug Cable Jack with Bend Reliefs MIL-STD-1553 .242" O.D. -30C +80C 78 Ohm Twinaxial Shielded twisted pair 1'	\$107.70
MSA00233-12N	Halogen Free Cable Assembly TRB 3-Slot Plug to Insulated Bulk Head 3-Lug Cable Jack with Bend Reliefs MIL-STD-1553 .242" O.D. -30C +80C 78 Ohm Twinaxial Shielded twisted pair 1'	\$98.27
MSA00235-12N	Halogen Free Cable Assembly TRB Non-Insulated Bulk Head 3-Lug Cable Jack to Jack MIL-STD-1553 .242" O.D. -30C +80C 78 Ohm Twinaxial Shielded twisted pair 1'	\$106.97

Assembly prices shown for 12" length. See our website for additional lengths.



Custom connectorization and configuration options available.

Part #	1 Piece Price	Feature	Specification
90-50206	\$669.37	bus & stub jacks	TRB 3-lug jacks
MSX000026	\$630.00 	tech note	non-terminated
		bus termination	none



**90-50206
MSX000026**

Part #	1 Piece Price	Feature	Specification
90-50216	\$716.64	bus & stub jacks	TRB 3-lug jacks
MSX000027	\$630.00 	tech note	single-terminated
		bus termination	one 78.7 ohm resistor



**90-50216
MSX000027**

Part #	1 Piece Price	Feature	Specification
90-51216	\$694.14	bus & stub jacks	TRB 3-lug jacks
MSX000028	\$630.00 	tech note	single-terminated
		bus termination	one 78.7 ohm resistor



**90-51216
MSX000028**

Part #	1 Piece Price	Feature	Specification
90-52216	\$736.57	bus & stub jacks	TRB 3-lug jacks
MSX000029	\$630.00 	tech note	single-terminated
		bus termination	one 78.7 ohm resistor



**90-52216
MSX000029**

Part #	1 Piece Price	Feature	Specification
90-50226	\$781.98	bus & stub jacks	TRB 3-lug jacks
MSX000030	\$630.00 	tech note	dual-terminated
		bus termination	two 78.7 ohm resistors



**90-50226
MSX000030**

Halogen Free Cable Assemblies

Item #	Description	1 Pc. Price
MSA00236-12N	Halogen Free Cable Assembly TRB Insulated Bulk Head Jack 3-Lug Cable Jack to Jack MIL-STD-1553 .242" O.D. -30C +80C 78 Ohm Twinaxial Shielded twisted pair 1'	\$118.01
MSA00237-12N	Halogen Free Cable Assembly TRB 3-Lug Cable Jack to Jack with Bend Reliefs MIL-STD-1553 .242" O.D. -30C +80C 78 Ohm Twinaxial Shielded twisted pair 1'	\$109.83
MSA00238-12N	Halogen Free Cable Assembly TRB Non-Insulated Bulk Head 3-Lug Cable Jack to Jack with Bend Reliefs MIL-STD-1553 .242" O.D. -30C +80C 78 Ohm Twinaxial Shielded twisted pair 1'	\$110.09
MSA00239-12N	Halogen Free Cable Assembly TRB Insulated Bulk Head 3-Lug Cable Jack to Jack with Bend Relief MIL-STD-1553 .242" O.D. -30C +80C 78 Ohm Twinaxial Shielded twisted pair 1'	\$123.69

Assembly prices shown for 12" length. See our website for additional lengths.



Custom connectorization and configuration options available.

MIL-STD-1553B | 7-Stub Data Bus Couplers



**90-50207
MSX000031**



**90-50217
MSX000032**



**90-51217
MSX000033**



**90-52217
MSX000034**



**90-50227
MSX000035**

Part #	1 Piece Price	Feature	Specification
90-50207	\$784.16	bus & stub jacks	TRB 3-lug jacks
MSX000031	\$740.00 ✓RoHS	tech note	non-terminated
		bus termination	none

Part #	1 Piece Price	Feature	Specification
90-50217	\$719.00	bus & stub jacks	TRB 3-lug jacks
MSX000032	\$740.00 ✓RoHS	tech note	single-terminated
		bus termination	one 78.7 ohm resistor

Part #	1 Piece Price	Feature	Specification
90-51217	\$785.25	bus & stub jacks	TRB 3-lug jacks
MSX000033	\$740.00 ✓RoHS	tech note	single-terminated
		bus termination	one 78.7 ohm resistor

Part #	1 Piece Price	Feature	Specification
90-52217	\$785.25	bus & stub jacks	TRB 3-lug jacks
MSX000034	\$740.00 ✓RoHS	tech note	single-terminated
		bus termination	one 78.7 ohm resistor

Part #	1 Piece Price	Feature	Specification
90-50227	\$840.41	bus & stub jacks	TRB 3-lug jacks
MSX000035	\$740.00 ✓RoHS	tech note	dual-terminated
		bus termination	two 78.7 ohm resistors

TRB Bus & Stub Terminators - Without Chain

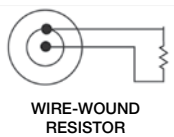

Terminator	Description	Resistor Value	1 Pc. Price
10-06403-025	bus terminator, without chain	78 ohm	\$64.25
10-06403-033	stub terminator, without chain	1000 ohm	\$90.16
10-06403-044	stub terminator, without chain	2000 ohm	\$93.32
10-06403-024	stub terminator, without chain	3000 ohm	\$91.33

TRB Bus & Stub Terminators - With 3 Inch Stainless Steel Chain



Terminator	Description	Resistor Value	1 Pc. Price
10-06403-060	bus terminator, 3" chain	78 ohm	\$71.43
10-06403-065	stub terminator, 3" chain	2000 ohm	\$81.28
10-06403-064	stub terminator, 3" chain	3000 ohm	\$87.82

Custom connectorization and configuration options available.

8-Stub Data Bus Couplers | MIL-STD-1553B

Part #	1 Piece Price	Feature	Specification
90-50208	\$878.35	bus & stub jacks	TRB 3-lug jacks
MSX000036	\$830.00 	tech note	non-terminated
		bus termination	none



90-50208
MSX000036

Part #	1 Piece Price	Feature	Specification
90-50218	\$1052.48	bus & stub jacks	TRB 3-lug jacks
MSX000037	\$830.00 	tech note	single-terminated
		bus termination	one 78.7 ohm resistor



90-50218
MSX000037

Part #	1 Piece Price	Feature	Specification
90-51218	\$964.79	bus & stub jacks	TRB 3-lug jacks
MSX000038	\$830.00 	tech note	single-terminated
		bus termination	one 78.7 ohm resistor



90-51218
MSX000038

Part #	1 Piece Price	Feature	Specification
90-52218	\$963.71	bus & stub jacks	TRB 3-lug jacks
MSX000039	\$830.00 	tech note	single-terminated
		bus termination	one 78.7 ohm resistor



90-52218
MSX000039

Part #	1 Piece Price	Feature	Specification
90-50228	\$1016.71	bus & stub jacks	TRB 3-lug jacks
MSX000040	\$830.00 	tech note	dual-terminated
		bus termination	two 78.7 ohm resistors



90-50228
MSX000040

TRB Bus & Stub Terminators - With 6 Inch Stainless Steel Chain

Terminator	Description	Resistor Value	1 Pc. Price
10-06403-026	bus terminator, 6" chain	78 ohm	\$67.79
10-06403-034	stub terminator, 6" chain	1000 ohm	\$91.33
10-06403-042	stub terminator, 6" chain	2000 ohm	\$91.33
10-06403-038	stub terminator, 6" chain	3000 ohm	\$91.33



WIRE-WOUND
RESISTOR

TRB RFI Dust Protection Caps - Stainless Steel Chain Options

RFI Cap	Description	1 Pc. Price
10-06300	RFI dust cap, without chain	\$15.08
10-06304	RFI dust cap, 3" chain	\$16.25
10-06303	RFI dust cap, 6" chain	\$16.25



10-06300



10-06304



10-06303

Custom connectorization and configuration options available.

1-Stub Inline Bus Couplers



90-50251-12

Part #	1 Piece Price
90-50251-12	\$323.40
Feature	Specification
bus & stub jacks	12" M17/176-00002 blunt ends
tech note	non-terminated
bus termination	none
nominal unit weight	1.50 oz (42.52 g)



90-50261-12

Part #	1 Piece Price
90-50261-12	\$335.25
Feature	Specification
bus & stub jacks	12" M17/176-00002 blunt ends
tech note	single-terminated
bus termination	one 78.7 ohm resistor
nominal unit weight	1.10 oz (31.18 g)



90-50361-12

Part #	1 Piece Price
90-50361-12	\$316.00
Feature	Specification
bus & stub jacks	12" M17/176-00002 blunt ends
tech note	single-terminated
bus termination	one 78.7 ohm resistor
nominal unit weight	1.10 oz (31.18 g)



90-50461-12

Part #	1 Piece Price
90-50461-12	\$311.00
Feature	Specification
bus & stub jacks	12" M17/176-00002 blunt ends
tech note	dual-terminated
bus termination	two 78.7 ohm resistor
nominal unit weight	0.70 oz (19.74 g)

2-Stub Inline Bus Couplers



90-50252-12

Part #	1 Piece Price
90-50252-12	\$442.38
Feature	Specification
bus & stub jacks	12" M17/176-00002 blunt ends
tech note	non-terminated
bus termination	none
nominal unit weight	1.90 oz (53.86 g)



90-50262-12

Part #	1 Piece Price
90-50262-12	\$477.76
Feature	Specification
bus & stub jacks	12" M17/176-00002 blunt ends
tech note	single-terminated
bus termination	one 78.7 ohm resistor
nominal unit weight	1.50 oz (42.52 g)



90-50362-12

Part #	1 Piece Price
90-50362-12	\$482.40
Feature	Specification
bus & stub jacks	12" M17/176-00002 blunt ends
tech note	single-terminated
bus termination	one 78.7 ohm resistor
nominal unit weight	1.50 oz (42.52 g)



90-50462-12

Part #	1 Piece Price
90-50462-12	\$505.61
Feature	Specification
bus & stub jacks	12" M17/176-00002 blunt ends
tech note	dual-terminated
bus termination	two 78.7 ohm resistor
nominal unit weight	1.10 oz (31.18 g)



90-50562-12

Part #	1 Piece Price
90-50562-12	\$521.34
Feature	Specification
bus & stub jacks	12" M17/176-00002 blunt ends
tech note	dual-terminated
bus termination	two 78.7 ohm resistor
nominal unit weight	1.10 oz (31.18 g)

Custom lengths and connectorization options are available.

3-Stub Inline Bus Couplers

Part #	1 Piece Price
90-50253-12	\$521.34
Feature	Specification
bus & stub jacks	12" M17/176-00002 blunt ends
tech note	non-terminated
bus termination	none
nominal unit weight	2.70 oz (76.54 g)

Part #	1 Piece Price
90-50363-12	\$526.24
Feature	Specification
bus & stub jacks	12" M17/176-00002 blunt ends
tech note	single-terminated
bus termination	one 78.7 ohm resistor
nominal unit weight	2.30 oz (65.20 g)

Part #	1 Piece Price
90-50563-12	\$592.80
Feature	Specification
bus & stub jacks	12" M17/176-00002 blunt ends
tech note	dual-terminated
bus termination	two 78.7 ohm resistor
nominal unit weight	1.90 oz (53.86 g)

Part #	1 Piece Price
90-50263-12	\$554.32
Feature	Specification
bus & stub jacks	12" M17/176-00002 blunt ends
tech note	single-terminated
bus termination	one 78.7 ohm resistor
nominal unit weight	2.30 oz (65.20 g)

Part #	1 Piece Price
90-50463-12	\$547.29
Feature	Specification
bus & stub jacks	12" M17/176-00002 blunt ends
tech note	single-terminated
bus termination	one 78.7 ohm resistor
nominal unit weight	2.30 oz (65.20 g)

Part #	1 Piece Price
90-50663-12	\$586.23
Feature	Specification
bus & stub jacks	12" M17/176-00002 blunt ends
tech note	dual-terminated
bus termination	two 78.7 ohm resistor
nominal unit weight	1.90 oz (53.86 g)



90-50253-12



90-50263-12



90-50363-12



90-50463-12



90-50563-12



90-50663-12

4-Stub Inline Bus Couplers

Part #	1 Piece Price
90-50254-12	\$688.79
Feature	Specification
bus & stub jacks	12" M17/176-00002 blunt ends
tech note	non-terminated
bus termination	none
nominal unit weight	3.10 oz (87.88 g)

Part #	1 Piece Price
90-50364-12	\$722.51
Feature	Specification
bus & stub jacks	12" M17/176-00002 blunt ends
tech note	single-terminated
bus termination	one 78.7 ohm resistor
nominal unit weight	2.70 oz (76.54 g)

Part #	1 Piece Price
90-50264-12	\$723.60
Feature	Specification
bus & stub jacks	12" M17/176-00002 blunt ends
tech note	single-terminated
bus termination	one 78.7 ohm resistor
nominal unit weight	2.70 oz (76.54 g)

Part #	1 Piece Price
90-50464-12	\$661.00
Feature	Specification
bus & stub jacks	12" M17/176-00002 blunt ends
tech note	dual-terminated
bus termination	one 78.7 ohm resistor
nominal unit weight	2.30 oz (65.20 g)

Part #	1 Piece Price
90-50564-12	\$661.00
Feature	Specification
bus & stub jacks	12" M17/176-00002 blunt ends
tech note	dual-terminated
bus termination	two 78.7 ohm resistor
nominal unit weight	2.30 oz (65.20 g)



90-50254-12



90-50264-12



90-50364-12



90-50464-12



90-50564-12

Custom lengths and connectorization options are available.

Stub Switching Relays



90-50270
90-50271

Part #	1 Piece Price
90-50270	\$339.24
Feature	Specification
nominal coil voltage	28V
bus input jack	one TRB 3-lug jack
bus output jack	one TRB 3-lug jack
interface connector	DB9 male

Part #	1 Piece Price
90-50271	\$339.24
Feature	Specification
nominal coil voltage	5V
bus input jack	one TRB 3-lug jack
bus output jack	one TRB 3-lug jack
interface connector	DB9 male

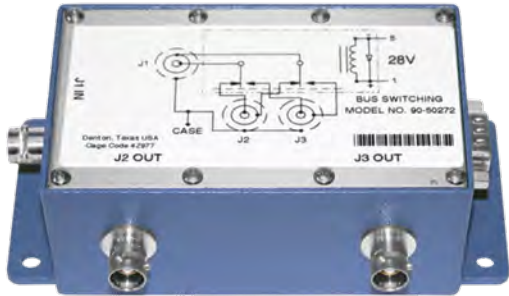

90-50272
90-50273

Bus Switching Relays

Part #	1 Piece Price
90-50272	\$419.26
Feature	Specification
nominal coil voltage	28V
bus input jack	one TRB 3-lug jack
bus output jack	two TRB 3-lug jack
interface connector	DB9 male

Part #	1 Piece Price
90-50273	\$419.26
Feature	Specification
nominal coil voltage	5V
bus input jack	one TRB 3-lug jack
bus output jack	two TRB 3-lug jack
interface connector	DB9 male



90-50274
90-50275

Bus Segmenting Relays

Part #	1 Piece Price
90-50274	\$515.06
Feature	Specification
nominal coil voltage	28V
bus input jack	two TRB 3-lug jack
bus output jack	one TRB 3-lug jack
interface connector	DB9 male

Part #	1 Piece Price
90-50275	\$515.06
Feature	Specification
nominal coil voltage	5V
bus input jack	two TRB 3-lug jack
bus output jack	one TRB 3-lug jack
interface connector	DB9 male



90-50277
90-50278

Dual Bus Switching

Part #	1 Piece Price
90-50277	\$849.79
Feature	Specification
nominal coil voltage	28V
bus input jack	two TRB 3-lug jack
bus output jack	four TRB 3-lug jack
interface connector	DB9 male

Part #	1 Piece Price
90-50278	\$817.10
Feature	Specification
nominal coil voltage	5V
bus input jack	two TRB 3-lug jack
bus output jack	four TRB 3-lug jack
interface connector	DB9 male

Custom lengths and connectorization options are available.

Data Bus Coupler Kits - 2 Terminal & 4 Terminal

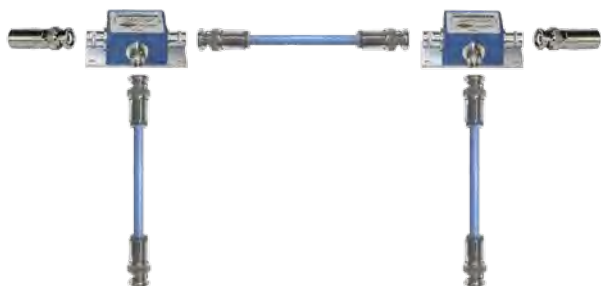

Part #	1 Piece Price
TK-1037	\$794.56

Quantity	Component	Part Number
2 each	1-stub bus couplers	90-50201
2 each	bus terminators	10-06403-025
1 each	bus cable assembly	CA-2009-72
2 each	stub cable assemblies	CA-2009-48

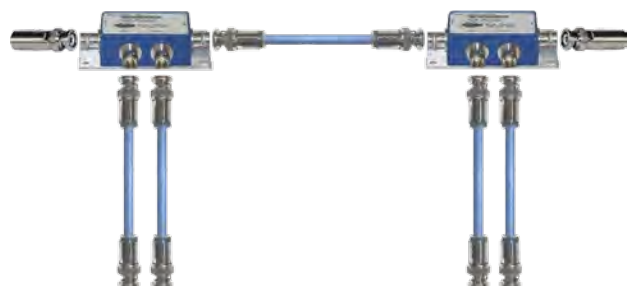

Part #	1 Piece Price
TK-1038	\$1215.55

Quantity	Component	Part Number
2 each	2-stub bus couplers	90-50202
2 each	bus terminators	10-06403-025
1 each	bus cable assembly	CA-2009-72
2 each	stub cable assemblies	CA-2009-48

Bus/Scope Test Cables



Part #	1 Piece Price
CA-5111	\$368.55

Feature	Specification
coaxial cable	75 ohm, 6.00 inches, BNC plugs
twinaxial cable	78 ohm, 60.00 inches, TRB plug

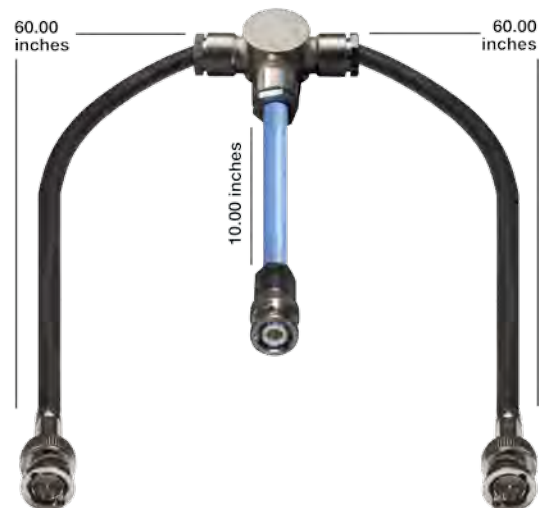

Part #	1 Piece Price
CA-5112	\$368.55

Feature	Specification
coaxial cable	75 ohm, 6.00 inches, BNC plugs
twinaxial cable	78 ohm, 10.00 inches, TRB plug

Custom Bus Kits

MilesTek data bus coupler kits offer a complete solution to laboratory application requirements. Pre-assembled kits guarantee compatibility between various MIL-STD-1553B components. Custom data bus coupler kits are available.

Bus/Scope Application

See application chart (right). Bus/scope test cables are typically used in laboratory testing environments. Bus/scope test cables are used with an oscilloscope to split and analyze individual signals on a bus.

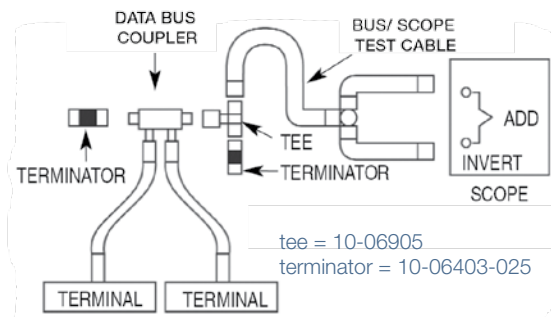

Vacuum Rated TVAC Twinaxial Cable Assemblies

Item #	Description	1 Pc. Price
MSA00001-12N	Vacuum Rated TVAC Twinaxial High Temp PFA Jacket 78 Ohm TRB 3 Slot Crimp Plug to TRB 3 Slot Crimp Plug .129" O.D. Cable Assembly -55C to +200C	\$573.10
MSA00002-12N	Vacuum Rated TVAC Twinaxial High Temp PFA Jacket 78 Ohm TRB 3 Slot Crimp Plug to Blunt .129" O.D. Cable Assembly -55C to +200C	\$338.65
MSA00003-12N	Vacuum Rated TVAC Twinaxial High Temp PFA Jacket 78 Ohm TRB 3 Slot Crimp Plug to TRS 3 Slot Crimp Plug .129" O.D. Cable Assembly -55C to +200C	\$573.10
MSA00004-12N	Vacuum Rated TVAC Twinaxial High Temp PFA Jacket 78 Ohm TRB 3 Slot Crimp Plug to TTM Threaded Crimp Plug .129" O.D. Cable Assembly -55C to +200C	\$573.10
MSA00005-12N	Vacuum Rated TVAC Twinaxial High Temp PFA Jacket 78 Ohm TRS 3 Slot Crimp Plug to TRS 3 Slot Crimp Plug .129" O.D. Cable Assembly -55C to +200C	\$573.10
MSA00006-12N	Vacuum Rated TVAC Twinaxial High Temp PFA Jacket 78 Ohm TRS 3 Slot Crimp Plug to Blunt .129" O.D. Cable Assembly -55C to +200C	\$338.65
MSA00007-12N	Vacuum Rated TVAC Twinaxial High Temp PFA Jacket 78 Ohm TRS 3 Slot Crimp Plug to TTM Threaded Crimp Plug .129" O.D. Cable Assembly -55C to +200C	\$573.10
MSA00008-12N	Vacuum Rated TVAC Twinaxial High Temp PFA Jacket 78 Ohm TTM Threaded Crimp Plug to TTM Threaded Crimp Plug .129" O.D. Cable Assembly -55C to +200C	\$573.10
MSA00009-12N	Vacuum Rated TVAC Twinaxial High Temp PFA Jacket 78 Ohm TTM Threaded Crimp Plug to Blunt .129" O.D. Cable Assembly -55C to +200C	\$338.65
MSA00010-12N	Vacuum Rated TVAC Twinaxial High Temp PFA Jacket 78 Ohm TCS Threaded Crimp Plug Pin to TCS Threaded Crimp Plug Pin .129" O.D. Cable Assembly -55C to +200C	\$677.30
MSA00011-12N	Vacuum Rated TVAC Twinaxial High Temp PFA Jacket 78 Ohm TCS Threaded Crimp Plug Pin to Blunt .129" O.D. Cable Assembly -55C to +200C	\$442.85
MSA00012-12N	Vacuum Rated TVAC Twinaxial High Temp PFA Jacket 78 Ohm TCS Threaded Crimp Plug Skt to TCS Threaded Crimp Plug Skt .129" O.D. Cable Assembly -55C to +200C	\$677.30
MSA00013-12N	Vacuum Rated TVAC Twinaxial High Temp PFA Jacket 78 Ohm TCS Threaded Crimp Plug Socket to Blunt .129" O.D. Cable Assembly -55C to +200C	\$442.85
MSA00014-12N	Vacuum Rated TVAC Twinaxial High Temp PFA Jacket 78 Ohm TRB 3 Slot Crimp Plug to TCS Threaded Crimp Plug Pin .129" O.D. Cable Assembly -55C to +200C	\$625.20
MSA00015-12N	Vacuum Rated TVAC Twinaxial High Temp PFA Jacket 78 Ohm TRB 3 Slot Crimp Plug to TCS Threaded Crimp Plug Socket .129" O.D. Cable Assembly -55C to +200C	\$625.20

Assembly prices shown for 12" length. See our website for additional lengths.

See our website, MilesTek.com to view all of our products.

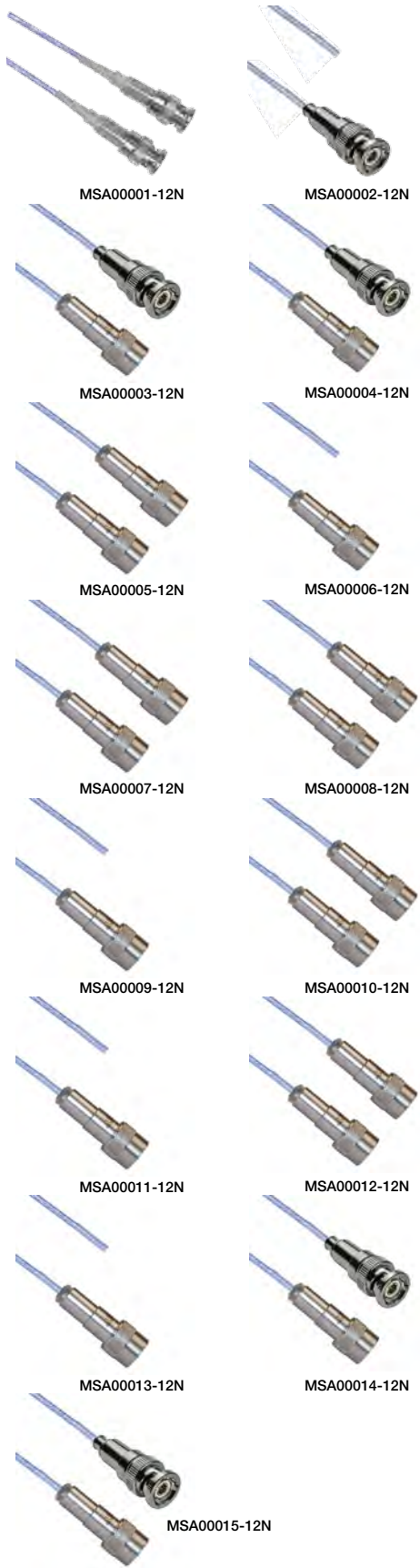

TRB Plenum Cable Assemblies

Item #	Description	1 Pc. Price
MSA00032-12N	Plenum Cable Assembly TRB 3-Slot Plug to Plug MIL-STD-1553 .150" O.D. +125C 78 Ohm Twinaxial Shielded Twisted Pair 1'	\$97.16
MSA00033-12N	Plenum Cable Assembly TRB 3-Slot Plug to Blunt MIL-STD-1553 .150" O.D. +125C 78 Ohm Twinaxial Shielded Twisted Pair 1'	\$85.70
MSA00034-12N	Plenum Cable Assembly TRB 3-Slot Plug to 3-Lug Cable Jack MIL-STD-1553 .150" O.D. +125C 78 Ohm Twinaxial Shielded Twisted Pair 1'	\$102.68
MSA00035-12N	Plenum Cable Assembly TRB 3-Slot Plug to Non-Insulated Bulk Head 3-Lug Cable Jack MIL-STD-1553 .150" O.D. +125C 78 Ohm Twinaxial Shielded Twisted Pair 1'	\$105.60
MSA00036-12N	Plenum Cable Assembly TRB 3-Slot Plug to Insulated Bulk Head 3-Lug Cable Jack MIL-STD-1553 .150" O.D. +125C 78 Ohm Twinaxial Shielded Twisted Pair 1'	\$109.30
MSA00037-12N	Plenum Cable Assembly TRB 3-Slot Plug to Plug with Bend Reliefs MIL-STD-1553 .150" O.D. +125C 78 Ohm Twinaxial Shielded Twisted Pair 1'	\$118.94
MSA00038-12N	Plenum Cable Assembly TRB 3-Slot Plug with Bend Relief to Blunt MIL-STD-1553 .150" O.D. +125C 78 Ohm Twinaxial Shielded Twisted Pair 1'	\$95.91
MSA00039-12N	Plenum Cable Assembly TRB 3-Slot Plug to 3-Lug Cable Jack with Bend Reliefs MIL-STD-1553 .150" O.D. +125C 78 Ohm Twinaxial Shielded Twisted Pair 1'	\$114.35
MSA00040-12N	Plenum Cable Assembly TRB 3-Slot Plug to Non-Insulated Bulk Head 3-Lug Cable Jack with Bend Reliefs MIL-STD-1553 .150" O.D. +125C 78 Ohm Twinaxial Shielded Twisted Pair 1'	\$114.46
MSA00041-12N	Plenum Cable Assembly TRB 3-Slot Plug to Insulated Bulk Head 3-Lug Cable Jack with Bend Reliefs MIL-STD-1553 .150" O.D. +125C 78 Ohm Twinaxial Shielded Twisted Pair 1'	\$119.98
MSA00042-12N	Plenum Cable Assembly TRB 3-Lug Cable Jack to Jack MIL-STD-1553 .150" O.D. +125C 78 Ohm Twinaxial Shielded Twisted Pair 1'	\$108.00
MSA00043-12N	Plenum Cable Assembly TRB Non-Insulated Bulk Head 3-Lug Cable Jack to Jack MIL-STD-1553 .150" O.D. +125C 78 Ohm Twinaxial Shielded Twisted Pair 1'	\$110.81
MSA00044-12N	Plenum Cable Assembly TRB Insulated Bulk Head Jack 3-Lug Cable Jack to Jack MIL-STD-1553 .150" O.D. +125C 78 Ohm Twinaxial Shielded Twisted Pair 1'	\$121.91
MSA00045-12N	Plenum Cable Assembly TRB 3-Lug Cable Jack to Jack with Bend Reliefs MIL-STD-1553 .150" O.D. +125C 78 Ohm Twinaxial Shielded Twisted Pair 1'	\$113.73
MSA00046-12N	Plenum Cable Assembly TRB Non-Insulated Bulk Head 3-Lug Cable Jack to Jack with Bend Reliefs MIL-STD-1553 .150" O.D. +125C 78 Ohm Twinaxial Shielded Twisted Pair 1'	\$113.52
MSA00047-12N	Plenum Cable Assembly TRB Insulated Bulk Head 3-Lug Cable Jack to Jack with Bend Relief MIL-STD-1553 .150" O.D. +125C 78 Ohm Twinaxial Shielded Twisted Pair 1'	\$127.64

Assembly prices shown for 12" length. See our website for additional lengths.

See our website, MilesTek.com to view all of our products.



MIL-STD-1553B | Lab Twinax Assemblies

30-02001 Cable - Lab-Rated Pvc, 0.242 Inch Overall Diameter

xxx = cable length in inches
CA-2009-72 = 6 ft. (72 in.) CA-2009-xxx assembly



Connector	Part Number	1 Pc. Price	Connector
10-06030-210 straight 3-slot solder/clamp plug	CA-2009-xxx	\$102.98	10-06030-210 straight 3-slot solder/clamp plug



Connector	Part Number	1 Pc. Price	Connector
10-06030-210 straight 3-slot solder/clamp plug	CA-2219-xxx	\$62.52	blunt - no connector



Connector	Part Number	1 Pc. Price	Connector
10-06030-210 straight 3-slot solder/clamp plug	CA-2171-xxx	\$106.46	10-06030-210 straight 3-slot solder/clamp plug



Connector	Part Number	1 Pc. Price	Connector
10-06030-210 straight 3-slot solder/clamp plug	MP-2177-xxx	\$97.95	10-06575-210 straight 3-lug solder/clamp jack



Connector	Part Number	1 Pc. Price	Connector
10-06030-210 straight 3-slot solder/clamp plug	MP-2268-xxx	\$109.41	10-06577-210 non-isolated 3-lug bulkhead jack



Connector	Part Number	1 Pc. Price	Connector
10-06030-210 straight 3-slot solder/clamp plug	MP-2192-xxx	\$104.20	10-06573-210 isolated 3-lug bulkhead jack



Connector	Part Number	1 Pc. Price	Connector
10-06575-210 straight 3-lug solder/clamp jack	MP-2218-xxx	\$104.20	10-06575-210 straight 3-lug solder/clamp jack



Connector	Part Number	1 Pc. Price	Connector
10-06575-210 straight 3-lug solder/clamp jack	MP-2275-xxx	\$87.53	blunt - no connector

xxx = cable length in inches
MP-2151-120 = 10 ft. (120 in.) MP-2151-xxx assembly



Connector	Part Number	1 Pc. Price	Connector
10-06033-210 bend relief, straight 3-slot solder/clamp plug	MP-2151-xxx	\$116.95	10-06033-210 bend relief, straight 3-slot solder/clamp plug



Connector	Part Number	1 Pc. Price	Connector
10-06033-210 bend relief, straight 3-slot solder/clamp plug	MP-2156-xxx	\$83.36	blunt - no connector



Connector	Part Number	1 Pc. Price	Connector
10-06031-210 straight 3-slot full crimp plug	MP-2357-xxx	\$109.78	blunt - no connector



Connector	Part Number	1 Pc. Price	Connector
10-06033-210 bend relief, straight 3-slot solder/clamp plug	MP-2396-xxx	\$104.20	10-06570-210 bend relief, straight 3-lug solder/clamp jack



Connector	Part Number	1 Pc. Price	Connector
10-06033-210 bend relief, straight 3-slot solder/clamp plug	MP-2624-xxx	\$83.36	10-06579-210 non-isolated, bend relief 3-lug bulkhead jack



Connector	Part Number	1 Pc. Price	Connector
10-06033-210 bend relief, straight 3-slot solder/clamp plug	MP-2414-xxx	\$117.75	10-06574-210 isolated, bend relief 3-lug bulkhead jack



Connector	Part Number	1 Pc. Price	Connector
10-06570-210 bend relief, straight 3-lug solder/clamp jack	MP-2540-xxx	\$107.33	10-06570-210 bend relief, straight 3-lug solder/clamp jack



Connector	Part Number	1 Pc. Price	Connector
10-06030-210 straight 3-slot solder/clamp plug	CA-2253-xxx	\$93.78	10-09030-210 straight threaded plug

Prices shown for 12" length. See our website for additional lengths.

Lab Twinax Assemblies | MIL-STD-1553B

30-02003 Cable - Lab-Rated Pvc, 0.150 Inch Overall Diameter

xxx = cable length in inches
CA-2014-72 = 6 ft. (72 in.) CA-2014-xxx assembly



Connector	Part Number	1 Pc. Price	Connector
10-06030-231 straight 3-slot solder/clamp plug	CA-2014-xxx	\$104.34	10-06030-231 straight
	MSA00470-03M	\$110.75	3-slot solder/clamp plug



Connector	Part Number	1 Pc. Price	Connector
10-06030-231 straight 3-slot solder/clamp plug	MP-2017-xxx	\$76.07	blunt
	MSA00471-03M	\$94.75	no connector



Connector	Part Number	1 Pc. Price	Connector
10-06031-231 straight 3-slot full crimp plug	MP-2352-xxx	\$132.34	10-06031-231 straight
			3-slot full crimp plug



Connector	Part Number	1 Pc. Price	Connector
10-06030-231 straight 3-slot solder/clamp plug	CA-2257-xxx	\$100.60	10-06575-231 straight
	MSA00472-03M	\$115.65	3-lug solder/clamp jack



Connector	Part Number	1 Pc. Price	Connector
10-06030-231 straight 3-slot solder/clamp plug	MP-2224-xxx	\$93.78	10-06577-231 non-isolated
	MSA00473-03M	\$119.65	3-lug bulkhead jack



Connector	Part Number	1 Pc. Price	Connector
10-06030-231 straight 3-slot solder/clamp plug	MP-2310-xxx	\$140.67	10-06573-231 isolated
	MSA00474-03M	\$128.65	3-lug bulkhead jack



Connector	Part Number	1 Pc. Price	Connector
10-06575-231 straight 3-lug solder/clamp jack	MP-2542-xxx	\$97.95	10-06575-231 straight
	MSA00480-03M	\$122.50	3-lug solder/clamp jack



Connector	Part Number	1 Pc. Price	Connector
10-06575-231 straight 3-lug solder/clamp jack	MP-2442-xxx	\$83.36	blunt
	MSA00481-03M	\$99.50	no connector

xxx = cable length in inches
MP-2164-120 = 10 ft. (120 in.) MP-2164-xxx assembly



Connector	Part Number	1 Pc. Price	Connector
10-06033-231 bend relief, straight 3-slot solder/clamp plug	MP-2164-xxx	\$130.20	10-06033-231 bend relief, straight
	MSA00475-03M	\$117.25	3-slot solder/clamp plug



Connector	Part Number	1 Pc. Price	Connector
10-06033-231 bend relief, straight 3-slot solder/clamp plug	MP-2347-xxx	\$80.24	blunt
	MSA00476-03M	\$96.90	no connector



Connector	Part Number	1 Pc. Price	Connector
10-06031-231 straight 3-slot full crimp plug	MP-2358-xxx	\$83.36	blunt
			no connector



Connector	Part Number	1 Pc. Price	Connector
10-06033-231 bend relief, straight 3-slot solder/clamp plug	MP-2397-xxx	\$108.37	10-06570-231 bend relief, straight
	MSA00477-03M	\$124.15	3-lug solder/clamp jack



Connector	Part Number	1 Pc. Price	Connector
10-06033-231 bend relief, straight 3-slot solder/clamp plug	MP-2625-xxx	\$104.20	10-06579-231 non-isolated, bend relief
	MSA00478-03M	\$128.15	3-lug bulkhead jack



Connector	Part Number	1 Pc. Price	Connector
10-06033-231 bend relief, straight 3-slot solder/clamp plug	MP-2415-xxx	\$114.62	10-06574-231 isolated, bend relief
	MSA00479-03M	\$124.15	3-lug bulkhead jack



Connector	Part Number	1 Pc. Price	Connector
10-06570-231 bend relief 3-lug solder/clamp jack	MP-2543-xxx	\$108.37	10-06570-231 bend relief, straight
	MSA00486-03M	\$131.00	3-lug solder/clamp jack



Connector	Part Number	1 Pc. Price	Connector
10-06570-231 bend relief, straight 3-lug solder/clamp jack	MP-2544-xxx	\$87.53	blunt
	MSA00487-03M	\$103.75	no connector

Prices shown for 12" and .03M lengths. See our website for additional lengths.

MIL-STD-1553B | Vehicle Twinax Assemblies

M17/176-00002 Cable - Vehicle High-Temp, 0.129 Inch Overall Diameter

xxx = cable length in inches
CA-2008-72 = 6 ft. (72 in.) CA-2008-xxx assembly



Connector	Part Number	1 Pc. Price	Connector
10-06030-206 straight 3-slot solder/clamp plug	CA-2008-xxx	\$117.90	10-06030-206 straight 3-slot solder/clamp plug
	MSA00436-03M	\$92.71	



Connector	Part Number	1 Pc. Price	Connector
10-06030-206 straight 3-slot solder/clamp plug	CA-2430-xxx	\$62.52	blunt
	MSA00437-03M	\$79.24	no connector



Connector	Part Number	1 Pc. Price	Connector
10-06031-206 straight 3-slot full crimp plug	CA-2001-xxx	\$140.62	10-06031-206 straight 3-slot full crimp plug

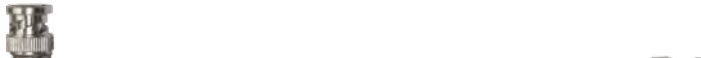

Connector	Part Number	1 Pc. Price	Connector
10-06032-206 right angle 3-slot full crimp plug	MP-2166-xxx	\$144.43	10-06031-206 straight 3-slot full crimp plug



Connector	Part Number	1 Pc. Price	Connector
10-06030-206 straight 3-slot solder/clamp plug	MP-2059-xxx	\$93.78	10-06575-206 straight 3-lug solder/clamp jack
	MSA00438-03M	\$96.73	



Connector	Part Number	1 Pc. Price	Connector
10-06030-206 straight 3-slot solder/clamp plug	MP-2252-xxx	\$146.93	10-06577-206 non-isolated 3-lug bulkhead jack
	MSA00439-03M	\$120.86	



Connector	Part Number	1 Pc. Price	Connector
10-06030-206 straight 3-slot solder/clamp plug	MP-2290-xxx	\$139.63	10-06573-206 isolated 3-lug bulkhead jack
	MSA00440-03M	\$132.20	



Connector	Part Number	1 Pc. Price	Connector
10-06030-206 straight 3-slot solder/clamp plug	CA-2416-xxx	\$113.36	10-07030-206 straight 4-slot solder/clamp plug

xxx = cable length in inches
MP-2165-120 = 10 ft. (120 in.) MP-2165-xxx assembly



Connector	Part Number	1 Pc. Price	Connector
10-06030-206 straight 3-slot solder/clamp plug	MP-2165-xxx	\$129.42	10-06033-206 bend relief, straight 3-slot solder/clamp plug
	MSA00441-03M	\$102.62	



Connector	Part Number	1 Pc. Price	Connector
10-06033-206 bend relief, straight 3-slot solder/clamp plug	CA-2342-xxx	\$83.36	blunt
	MSA00442-03M	\$83.42	no connector



Connector	Part Number	1 Pc. Price	Connector
10-06031-206 straight 3-slot full crimp plug	MP-2359-xxx	\$69.82	blunt no connector



Connector	Part Number	1 Pc. Price	Connector
10-06032-206 right angle 3-slot full crimp plug	MP-2167-xxx	\$207.46	10-06032-206 right angle 3-slot full crimp plug



Connector	Part Number	1 Pc. Price	Connector
10-06033-206 bend relief, straight 3-slot solder/clamp plug	MP-2398-xxx	\$117.75	10-06570-206 bend relief, straight 3-lug solder/clamp jack
	MSA00443-03M	\$105.73	



Connector	Part Number	1 Pc. Price	Connector
10-06033-206 bend relief, straight 3-slot solder/clamp plug	MP-2411-xxx	\$104.20	10-06579-206 non-isolated, bend relief 3-lug bulkhead jack
	MSA00444-03M	\$108.25	



Connector	Part Number	1 Pc. Price	Connector
10-06575-206 straight 3-lug solder/clamp jack	MP-2041-xxx	\$101.08	10-06575-206 straight 3-lug solder/clamp jack
	MSA00446-03M	\$102.37	



Connector	Part Number	1 Pc. Price	Connector
10-06030-206 straight 3-slot solder/clamp plug	MP-2377-xxx	\$90.66	10-08030-206 straight 2-slot solder/clamp plug
	MSA00466-03M	\$92.19	

Prices shown for 12" and .03M lengths. See our website for additional lengths.

Vehicle Twinax Assemblies | MIL-STD-1553B

30-02002 Cable - Vehicle High-Temp, 0.095 Inch Overall Diameter

xxx = cable length in inches
MP-2168-72 = 6 ft. (72 in.) MP-2168-xxx assembly

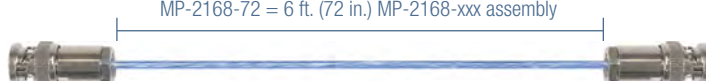

Connector	Part Number	1 Pc. Price	Connector
10-06030-242 straight 3-slot solder/clamp plug	MP-2168-xxx	\$127.20	10-06030-242 straight 3-slot solder/clamp plug



Connector	Part Number	1 Pc. Price	Connector
10-06030-242 straight 3-slot solder/clamp plug	MP-2364-xxx	\$79.20	blunt - no connector



Connector	Part Number	1 Pc. Price	Connector
10-06030-242 straight 3-slot solder/clamp plug	MP-2395-xxx	\$93.78	10-06575-242 straight 3-lug solder/clamp jack



Connector	Part Number	1 Pc. Price	Connector
10-06030-242 straight 3-slot solder/clamp plug	MP-2623-xxx	\$97.95	10-06577-242 non-isolated 3-lug bulkhead jack



Connector	Part Number	1 Pc. Price	Connector
10-06030-242 straight 3-slot solder/clamp plug	MP-2413-xxx	\$139.84	10-06573-242 isolated 3-lug bulkhead jack



Connector	Part Number	1 Pc. Price	Connector
10-06575-242 straight 3-lug solder/clamp jack	MP-2545-xxx	\$100.04	10-06575-242 straight 3-lug solder/clamp jack



Connector	Part Number	1 Pc. Price	Connector
10-06575-242 straight 3-lug solder/clamp jack	MP-2443-xxx	\$158.84	blunt - no connector

xxx = cable length in inches
MP-2360-120 = 10 ft. (120 in.) MP-2360-xxx assembly

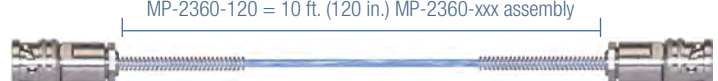

Connector	Part Number	1 Pc. Price	Connector
10-06033-242 bend relief, straight 3-slot solder/clamp plug	MP-2360-xxx	\$132.34	10-06033-242 bend relief, straight 3-slot solder/clamp plug



Connector	Part Number	1 Pc. Price	Connector
10-06033-242 bend relief, straight 3-slot solder/clamp plug	MP-2365-xxx	\$87.53	blunt - no connector



Connector	Part Number	1 Pc. Price	Connector
10-06033-242 bend relief, straight 3-slot solder/clamp plug	MP-2399-xxx	\$108.37	10-06570-242 bend relief, straight 3-lug solder/clamp jack



Connector	Part Number	1 Pc. Price	Connector
10-06033-242 bend relief, straight 3-slot solder/clamp plug	MP-2412-xxx	\$104.20	10-06579-242 non-isolated, bend relief 3-lug bulkhead jack



Connector	Part Number	1 Pc. Price	Connector
10-06033-242 bend relief, straight 3-slot solder/clamp plug	MP-2417-xxx	\$160.68	10-06574-242 isolated, bend relief 3-lug bulkhead jack



Connector	Part Number	1 Pc. Price	Connector
10-06570-242 bend relief, straight 3-lug solder/clamp jack	MP-2546-xxx	\$132.34	10-06570-242 bend relief, straight 3-lug solder/clamp jack



Connector	Part Number	1 Pc. Price	Connector
10-06570-242 bend relief, straight 3-lug solder/clamp jack	MP-2547-xxx	\$87.53	blunt - no connector

Prices shown for 12" length. See our website for additional lengths.



Crimp Tools & Positioners

page 28



Bus Couplers

pages 6-11



RFI Caps

page 11



Adapters

page 24

MIL-STD-1553B | 78 Ohm Twinax Cable



30-02001
assemblies page 18



30-02003
assemblies pages 19, 27



M17/176-00002
assemblies pages 20, 26



30-02002
assemblies page 21

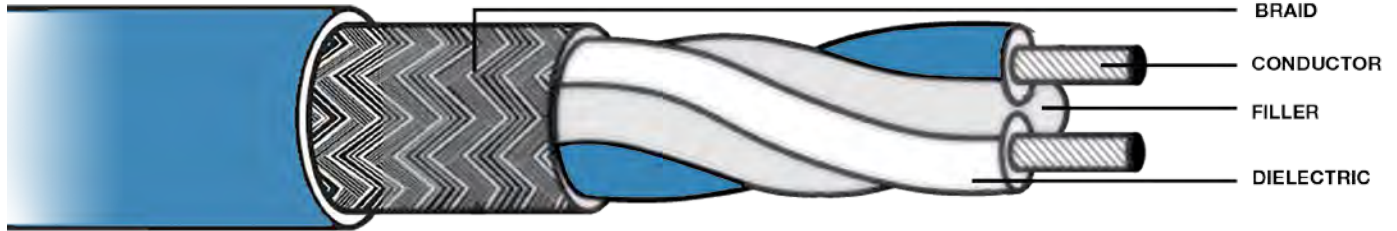

MilesTek	Lab-Rated Twinaxial Cable		Vehicle-Rated High-Temp Twinaxial Cable	
Cable Type Part Number	30-02001	30-02003	M17/176-00002	30-02002
Price Per Foot	\$2.28	\$2.23	\$4.52	\$5.76
uses MilesTek connector	-210	-231	-206	-242
Specifications				
nominal impedance (ohms)	78 ± 3	78 ± 3	77 ± 7	77 ± 7
nominal outer diameter (inches)	0.242	0.15	0.129	0.095
conductor diameter (inches)	0.037	0.022	0.024	0.0149
operating temperature range	-20°C to +75°C	-20°C to +75°C	-55°C to +200°C	-55°C to +200°C
minimum bend radius (inches)	2.42	1.5	1.5	1.25
nominal capacitance (pF/ft.)	19.7	20.3	24	23
outer jacket material	PVC	PVC	Teflon® FEP	PFA
insulation material	PVC	PVC	Teflon® FEP	FEP
shield coverage	0.93	0.93	0.93	0.9
Attenuation (Db/100 Ft.)				
1 MHz	0.6	2	1.4	2
3 MHz		3	2.1	
10 MHz	2.1	5.3	4.500 (max.)	6.5
20 MHz		7.5		
30 MHz		9.2		
40 MHz		10.6		
50 MHz	5	11.9		
100 MHz	7.5	16.8		
200 MHz	11	23.7		
400 MHz	16	--		
500 MHz		37.5		
700 MHz		44.3		
1000 MHz		53		

Alternate Cable Options

Plenum, low smoke, high-temperature, and halogen-free bulk cable is also available. For any other bulk cable needs or requests, please contact MilesTek.

TRB & TRS Bushing/Shield Crimp Tools - Compatible Set

Crimp Tool Description	Part Number	1 Pc. Price
bushing/shield crimp handle	M22520/5-01	\$364.70
TRB crimp die set	CD5-8 (Y778)	\$590.77
TRS crimp die set	CD5-9 (Y687)	\$864.05



M22520/5-01



CD5-8 (Y778)



CD5-9 (Y687)

TRB Center Contact Crimp Tools - Compatible Set

Crimp Tool Description	Part Number	1 Pc. Price
center contact crimp handle	M22520/1-01	\$328.23
TRB center pin positioner	010-0044 (TP837)	\$223.28
TRB center socket positioner	010-0045 (TP838)	\$220.03



M22520/1-01



010-0044 (TP837)



010-0045 (TP838)

TRS Submin Center Contact Crimp Tools - Compatible Set

Crimp Tool Description	Part Number	1 Pc. Price
center contact crimp handle	M22520/2-01	\$513.71
TRS center pin positioner	010-0041 (K815-S)	\$204.61



M22520/2-01



010-0041 (K815-S)

M17/176-00002 Cable Splicing Tools - Compatible Set

Splicing Tool Description	Part Number	1 Pc. Price
splice crimp tool	AD-1377	\$403.83
eight-piece splicing kit	10-06950	\$87.53

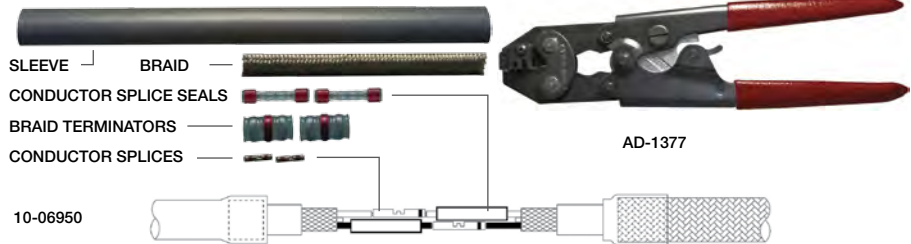

10-06950

AD-1377

Crimp Tool Compatibility Guide

Full Crimp Connector Series	Cable Group	Cable Part Number	Bushing/Shield Crimp Handle	Bushing/Shield Crimp Die Set	Center Contact Crimp Handle	Center Contact Positioner
TRB Standard (full crimp - page 32) 10-06031-xxx 10-06032-xxx 10-06576-xxx	-210	30-02001 TWC-78-2 TWC-124-2	M22520/5-01	CD5-8 (Y778)	M22520/1-01	010-0044 (TP837) use for pin contacts (plugs)
	-231	30-02003 TWC-78-1 TWC-124-1A				010-0045 (TP838) use for socket contacts (jacks)
	-206	M17/176-00002				
	-242	30-02002				
TRS Subminiature (full crimp - page 40) 10-10031-xxx 10-10032-xxx	-231	30-02003 TWC-78-1 TWC-124-1A	M22520/5-01	CD5-9 (Y687)	M22520/2-01	010-0041 (K815-S) use for pin (plugs) & socket (jacks) contacts
	-206	M17/176-00002				
	-242	30-02002				

MIL-STD-1553B | TRB Connectors & Adapters

TRB Cable Plug 3-Slot, Full Crimp



Compatible Twinax Cable Type	Straight	1 Pc. Price	Right Angle	1 Pc. Price
30-02001, TWC-78-2, TWC-124-2	10-06031-210	\$21.62	-	
30-02003, TWC-78-1, TWC-124-1A	10-06031-231	\$21.22	-	
M17/176-00002	10-06031-206	\$20.69	10-06032-206	\$107.07
Specifications - Dimensions		Straight	Right Angle	
overall body width - inches (mm)	0.57" (14.50)		-	
overall body length - inches (mm)	1.70" (43.18)		-	
overall body height - inches (mm)	-		1.13" (28.70)	

TRB Bulkhead Jack To Solder Pot (Non-Isolated) Mating Options



Mating Interface	Front Mount	1 Pc. Price	Rear Mount	1 Pc. Price
3-lug female jack	10-06569	\$28.73	10-06570	\$29.28
Specifications - Dimensions		Front Mount	Rear Mount	
mounting hole size - see chart below	D2.125		D3.218	
overall body width - inches (mm)	0.56" (14.27)		0.69" (17.45)	
overall body length - inches (mm)	1.12" (28.50)		1.31" (33.32)	

TRB Bulkhead Jack To Solder Pot (Isolated) Mating Options

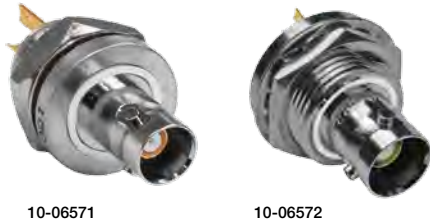

Mating Interface	Front Mount	1 Pc. Price	Rear Mount	1 Pc. Price
3-lug female jack	10-06571	\$35.13	10-06572	\$34.80
Specifications - Dimensions		Front Mount	Rear Mount	
mounting hole size - see chart below	D2.140		D2.140	
overall body width - inches (mm)	0.87" (22.04)		0.87" (22.04)	
overall body length - inches (mm)	1.37" (34.80)		1.37" (34.80)	

TRB Bulkhead Jack Feedthru (Isolated & Non-Isolated) Mating Options



Mating interface	Isolated	1 Pc. Price	Non-isolated	1 Pc. Price
3-lug female jack feedthru	10-06568	\$41.71	10-06567	\$38.69
Specifications - Dimensions		Isolated	Non-Isolated	
mounting hole size - see chart below	D2.140		D3.187	
overall body width - inches (mm)	0.80" (20.32)		0.73" (18.60)	
overall body length - inches (mm)	1.29" (32.77)		1.29" (32.77)	

TRB Standard Within-Series Adapters



Description	Mating Interface	Adapter	1 Pc. Price
TRB 3-lug jack to TRB 3-lug jack	feedthru female to female	10-06901	\$28.73
TRB 3-slot plug to two TRB 3-lug jacks	tee female-male-female	10-06905	\$101.58
TRB 3-slot plug to TRB 3-lug jack	right angle male to female	10-06909	\$101.10

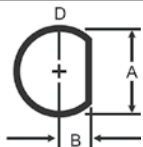

Mounting Hole Sizes

D1 = (A) 0.755-0.760" (B) 0.343-0.346"
D2 = (A) 0.630-0.635" (B) 0.281-0.284"
D3 = (A) 0.505-0.510" (B) 0.218-0.221"
D4 = (A) 0.439-0.443" (B) 0.187-0.190"

D2.140

maximum panel thickness in inches

D5 = (A) 0.380-0.384" (B) 0.156-0.159"

D6 = (A) 0.317-0.321" (B) 0.128-0.131"

D7 = (A) 0.281-0.285" (B) 0.125-0.128"

D8 = (A) 0.439-0.443" (B) 0.187-0.190"

D9 = (A) 0.567-0.572" (B) 0.257-0.260"

D7.250

maximum panel thickness in inches

Plug	1 Pc. Price	Plug + Spring	1 Pc. Price	Compatible Twinax Cable Type
10-06030-210	\$19.53	10-06033-210	\$25.52	30-02001, TWC-78-2, TWC-124-2
10-06030-231	\$19.35	10-06033-231	\$24.30	30-02003, TWC-78-1, TWC-124-1A
10-06030-206	\$19.35	10-06033-206	\$25.52	M17/176-00002
10-06030-242	\$19.72	10-06033-242	\$24.30	30-02002, TWAC-78-1F2
10-06030-227	\$19.91	10-06033-227	\$25.76	0024A0024-9X

Plug	Plug + Spring	Specifications - Dimensions
0.57" (14.50)	0.57" (14.50)	overall body width - inches (mm)
1.12" (28.50)	1.12" (28.50)	overall body length - inches (mm)
-	1.85" (46.88)	spring length - inches (mm)

TRB Cable Plug - 3-Slot, Solder/Clamp



Jack	1 Pc. Price	Jack + Spring	1 Pc. Price	Compatible Twinax Cable Type
10-06575-210	\$29.28	10-06570-210	\$35.43	30-02001, TWC-78-2, TWC-124-2
10-06575-231	\$29.01	10-06570-231	\$35.43	30-02003, TWC-78-1, TWC-124-1A
10-06575-206	\$28.73	10-06570-206	\$40.43	M17/176-00002
10-06575-242	\$29.01	10-06570-242	\$35.43	30-02002, TWAC-78-1F2

Jack	Jack + Spring	Specifications - Dimensions
0.57" (14.50)	0.57" (14.50)	overall body width - inches (mm)
1.31" (33.40)	1.31" (33.40)	overall body length - inches (mm)
-	1.85" (46.88)	spring length - inches (mm)

TRB Cable Jack - 3-Lug, Solder/Clamp



Jack	1 Pc. Price	Jack + Spring	1 Pc. Price	Compatible Twinax Cable Type
10-06577-210	\$32.79	10-06579-210	\$37.52	30-02001, TWC-78-2, TWC-124-2
10-06577-231	\$32.79	10-06579-231	\$37.52	30-02003, TWC-78-1, TWC-124-1A
10-06577-206	\$32.17	10-06579-206	\$37.52	M17/176-00002
10-06577-242	\$30.93	10-06579-242	\$37.52	30-02002, TWAC-78-1F2

Jack	Jack + Spring	Specifications - Dimensions
D3.157	D3.157	mounting hole size - see chart pg 24
0.69" (17.50)	0.69" (17.50)	overall body width - inches (mm)
1.41" (35.81)	1.41" (35.81)	overall body length - inches (mm)
-	1.85" (46.88)	spring length - inches (mm)

TRB Bulkhead Cable Jack - 3-Lug, Solder/Clamp (Non-Isolated)



Jack	1 Pc. Price	Jack + Spring	1 Pc. Price	Compatible Twinax Cable Type
10-06573-210	\$34.40			30-02001, TWC-78-2, TWC-124-2
10-06573-231	\$34.40	10-06574-231	\$46.89	30-02003, TWC-78-1, TWC-124-1A
10-06573-206	\$34.08			M17/176-00002
10-06573-242	\$32.45			30-02002, TWAC-78-1F2

Jack	Jack + Spring	Specifications - Dimensions
D2.157	-	mounting hole size - see chart pg 24
0.87" (22.04)	0.87" (22.04)	overall body width - inches (mm)
1.41" (35.81)	-	overall body length - inches (mm)
-	-	spring length - inches (mm)

TRB Bulkhead Cable Jack - 3-Lug, Solder/Clamp (Isolated)





SUBMINIATURE | Vehicle Twinax Assemblies

M17/176-00002 Cable - Vehicle High-Temp, 0.129 Inch Overall Diameter

xxx = cable length in inches
CA-2414-72 = 6 ft. (72 in.) CA-2414-xxx assembly



Connector	Part Number	1 Pc. Price	Connector
10-10030-206 subminiature, straight 3-slot solder/clamp plug	CA-2414-xxx	\$109.16	10-06030-206 straight 3-slot solder/clamp plug
	MSA00456-03M	\$96.80 	



Connector	Part Number	1 Pc. Price	Connector
10-10030-206 subminiature, straight 3-slot solder/clamp plug	MP-3006-xxx	\$97.95	10-06575-206 straight 3-lug solder/clamp jack



Connector	Part Number	1 Pc. Price	Connector
10-10031-206 subminiature, straight 3-slot full crimp plug	MP-2079-xxx	\$121.92	10-06031-206 straight 3-slot full crimp plug



Connector	Part Number	1 Pc. Price	Connector
10-10031-206 subminiature, straight 3-slot full crimp plug	MP-2186-xxx	\$120.88	blunt - no connector



Connector	Part Number	1 Pc. Price	Connector
10-12030-206 subminiature, straight threaded plug	MP-2006-xxx	\$135.46	10-10030-206 subminiature, straight 3-slot solder/clamp plug
	MSA00459-03M	\$153.53 	



Connector	Part Number	1 Pc. Price	Connector
10-12030-206 subminiature, straight threaded plug	MP-5259-xxx	\$121.92	blunt - no connector
	MSA00461-03M	\$134.00 	



Connector	Part Number	1 Pc. Price	Connector
10-12031-206 subminiature, straight threaded full crimp plug	MP-2485-xxx	\$163.81	10-06031-206 straight 3-slot full crimp plug

xxx = cable length in inches
MP-2134-120 = 10 ft. (120 in.) MP-2134-xxx assembly



Connector	Part Number	1 Pc. Price	Connector
10-10030-206 subminiature, straight 3-slot solder/clamp plug	MP-2134-xxx	\$93.78	10-10030-206 subminiature, straight 3-slot solder/clamp plug
	MSA00457-03M	\$104.07 	



Connector	Part Number	1 Pc. Price	Connector
10-10030-206 subminiature, straight 3-slot solder/clamp plug	MP-2341-xxx	\$77.11	blunt - no connector
	MSA00458-03M	\$84.93 	



Connector	Part Number	1 Pc. Price	Connector
10-10031-206 subminiature, straight 3-slot full crimp plug	CA-2095-xxx	\$281.34	10-10031-206 subminiature, straight 3-slot full crimp plug



Connector	Part Number	1 Pc. Price	Connector
10-12030-206 subminiature, straight threaded plug	MP-2277-xxx	\$145.88	10-12030-206 subminiature, straight threaded plug
	MSA00460-03M	\$203.00 	



Connector	Part Number	1 Pc. Price	Connector
10-12030-206 subminiature, straight threaded plug	MP-2004-xxx	\$135.46	10-06030-206 straight 3-slot solder/clamp plug



Connector	Part Number	1 Pc. Price	Connector
10-12031-206 subminiature, straight threaded full crimp plug	MP-2096-xxx	\$163.81	10-12031-206 subminiature, straight threaded full crimp plug



Connector	Part Number	1 Pc. Price	Connector
10-12031-206 subminiature, straight threaded full crimp plug	MP-2305-xxx	\$142.76	blunt - no connector

Prices shown for 12" and .03M lengths. See our website for additional lengths.

TRS Submin Cable Plug - 3-Slot, Solder/Clamp



10-10030-xxx

Compatible Twinax Cable Type	Plug	1 Pc. Price
30-02003, TWC-78-1, TWC-124-1A	10-10030-231	\$28.72
M17/176-00002	10-10030-206	\$28.72
Specifications - Dimensions		Plug
overall body width - inches (mm)		0.46" (11.68)
overall body length - inches (mm)		0.83" (21.08)

MilesTek

an INFINIT® brand

30-02003 Cable - Lab-Rated Pvc, 0.150 Inch Overall Diameter

Assembly #	Cable Type	Application	1 Pc. Price
CA-2005-xxx	30-02003	laboratory	\$120.65
MSA00490-03M	30-02003	laboratory	\$120.99 

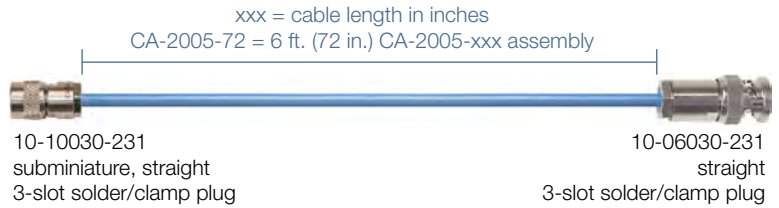

Assembly #	Cable Type	Application	1 Pc. Price
CA-2375-xxx	30-02003	laboratory	\$82.32

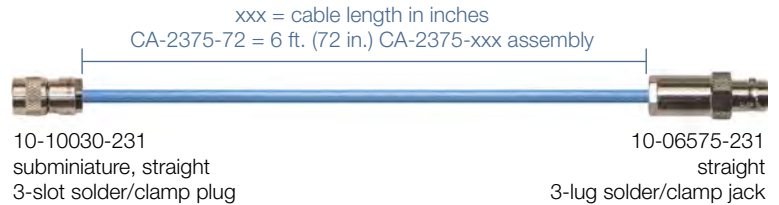

Assembly #	Cable Type	Application	1 Pc. Price
MP-2474-xxx	30-02003	laboratory	\$111.67
MSA00493-03M	30-02003	laboratory	\$247.65 

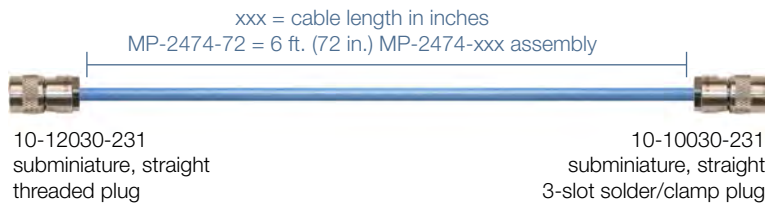

Assembly #	Cable Type	Application	1 Pc. Price
MP-2478-xxx	30-02003	laboratory	\$111.50
MSA00495-03M	30-02003	laboratory	\$223.65 

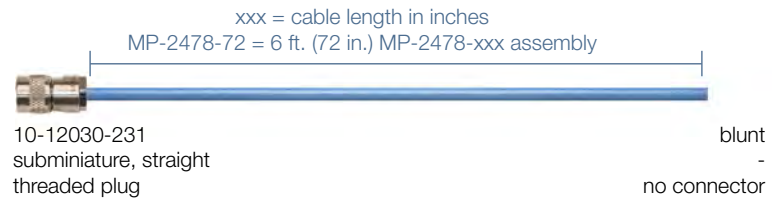

Assembly #	Cable Type	Application	1 Pc. Price
MP-2018-xxx	30-02003	laboratory	\$93.78
MSA00491-03M	30-02003	laboratory	\$126.50 

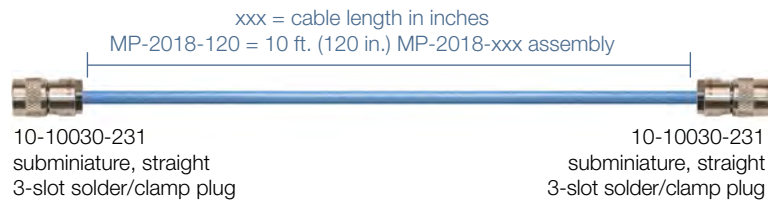

Assembly #	Cable Type	Application	1 Pc. Price
MP-2456-xxx	30-02003	laboratory	\$93.78
MSA00492-03M	30-02003	laboratory	\$102.50 

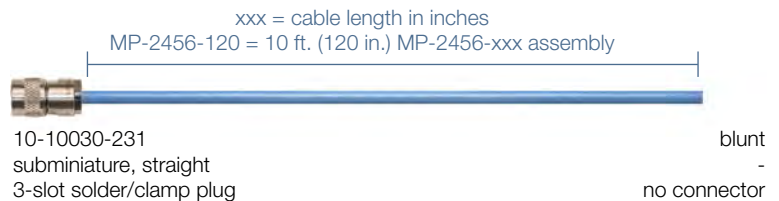

Assembly #	Cable Type	Application	1 Pc. Price
MP-2098-xxx	30-02003	laboratory	\$164.00
MSA00494-03M	30-02003	laboratory	\$368.80 

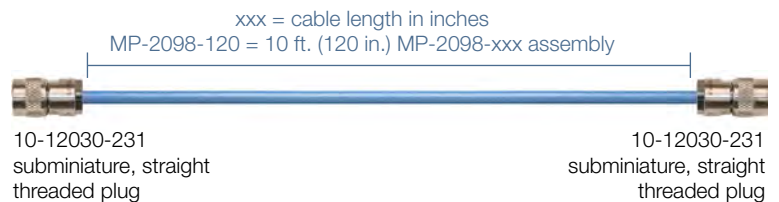

Assembly #	Cable Type	Application	1 Pc. Price
MP-2229-xxx	30-02003	laboratory	\$132.34

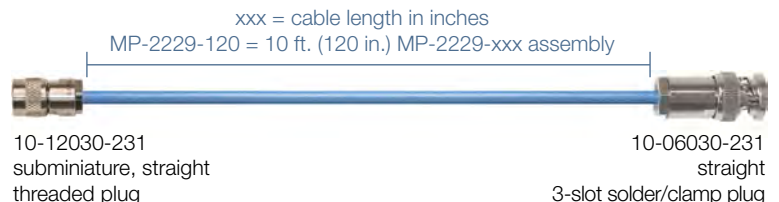

Prices shown for 12" and .03M lengths. See our website for additional lengths.



3-slot, 3-lug



2-slot, 2-lug



4-slot, 4-lug



threaded

Mating Interfaces

Standard MilesTek TRB 3-slot plugs and TRB 3-lug jacks are the most common mating interfaces. MilesTek also offers connectors in 2-slot/lug, 4-slot/lug, and threaded mating interfaces. Call to request these alternate mating solutions.

TRS Submin Center Contact Crimp Tools - Compatible Set



M22520/2-01



010-0041 (K815-S)

Crimp Tool Description	Part Number	1 Pc. Price
center contact crimp handle	M22520/2-01	\$513.71
TRS center pin positioner	010-0041 (K815-S)	\$204.61

TRS Submin Crimp Tool Compatibility Guide

full crimp connector series	cable group	cable part number	bushing/shield crimp handle	bushing/shield crimp die set	center contact crimp handle	center contact positioner
TRS subminiature full crimp 10-10031-xxx 10-10032-xxx	-231	30-02003 TWC-78-1 TWC-124-1A	M22520/5-01	CD5-9 (Y687)	M22520/2-01	010-0041 (K815-S) use for pin (plugs) & socket (jacks) contacts
	-206	M17/176-00002				
	-242	30-02002				

TRB Standard v. TRS Subminiature

TRB Standard Connectors

Standard (TRB) connectors are designed for extreme durability and heavy-use applications. TRB connectors are the most common interface size (same size as BNC/TNC series). This connector series is not recommended for weight-sensitive applications. The maximum outer cable diameter is 0.475 inches (large-body versions are available for larger cables).

TRS Subminiature Connectors

Subminiature (TRS) connectors are preferred in applications that require weight reduction, high packing density, and noise-free guarded circuits. TRS connectors can increase packing density to more than 240% compared to TRB standard connectors. The reduced size limits the maximum outer cable diameter to 0.250 inches.



10-06030-xxx



**3-SLOT
TRB PLUG**



**3-SLOT
TRS PLUG**



10-10030-xxx



0024A0024-9X

assembly & components below

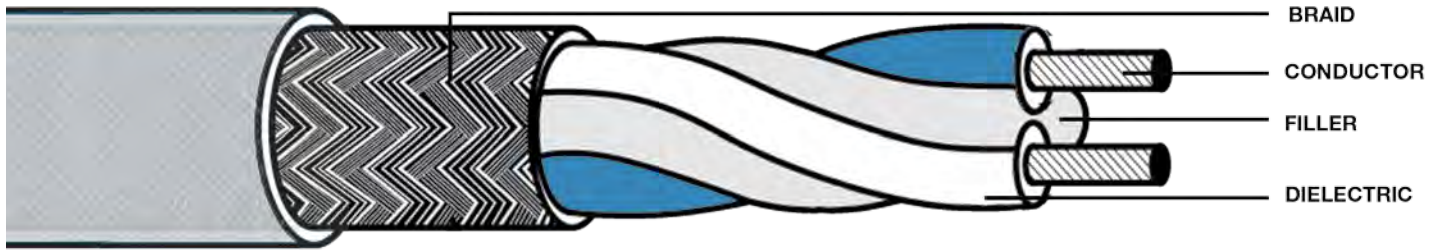

MilesTek 100 Ohm Twinaxial Cable

cable type part number	0024A0024-9X
Price Per Foot	\$11.00
uses MilesTek connector	-227

Specifications

nominal impedance (ohms)	100 ± 7
nominal outer diameter (inches)	0.149
conductor diameter (inches)	0.025
max. operating VDC	1000 V _{RMS}
max. operating VAC (RMS)	1.0 kV
minimum bend radius (inches)	1.788
max. capacitance (pF/ft.)	13.5 (mutual)
outer jacket material	Modified FEP
insulation material	Rayfoam® H
shield coverage	90%

Attenuation (dB/100 ft.)

1 MHz	0.300
3 MHz	
10 MHz	1.200
20 MHz	
30 MHz	
40 MHz	
50 MHz	2.800
100 MHz	4.100
200 MHz	6.400
400 MHz	10.200

100 Ohm TRB Plug To Plug Cable Assembly

xxx = cable length in inches
 MP-5771-120 = 10 ft. (120 in.) MP-5771-xxx assembly



Connector	Part Number	1 Pc. Price	Connector
10-06030-227 straight 3-slot solder/clamp plug	MP-5771-xxx	\$163.60	10-06030-227 straight 3-slot solder/clamp plug

Prices shown for 12" length. See our website for additional lengths.

100 Ohm TRB Cable Plug - 3-Slot, Solder/Clamp



Compatible Twinax Cable Type	Plug	1 Pc. Price
0024A0024-9X	10-06030-227	\$19.91

Specifications - Dimensions	Plug
overall body width - inches (mm)	0.57" (14.50)
overall body length - inches (mm)	1.12" (28.50)

TWINAXIAL | 124 Ohm Twinax Cable



TWC-124-2
assemblies page 31



TWC-124-1A
assemblies page 31

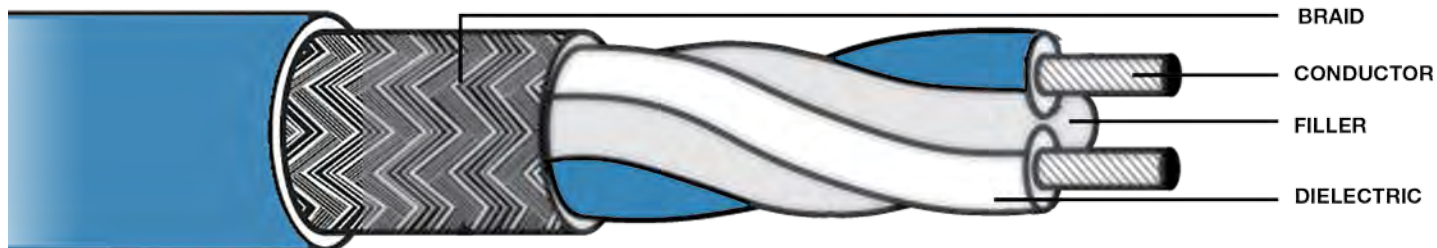

MilesTek 124 Ohm Twinaxial Cable		
Cable Type Part Number	TWC-124-2	TWC-124-1A
Price Per Foot	\$2.30	\$2.30
uses MilesTek connector	-210	-231
Specifications		
nominal impedance (ohms)	124 ± 4	124 ± 5
nominal outer diameter (inches)	0.245	0.150
conductor diameter (inches)	0.022	0.012
max. operating VDC	2.0 kV	0.6kV
max. operating VAC (RMS)	1.0 kV	0.3 kV
minimum bend radius (inches)	1.25	1.50
max. capacitance (pF/ft.)	12.30	12.40
outer jacket material	PVC	PVC
insulation material	PVC	PVC
shield coverage	93%	93%
Attenuation (dB/100 ft.)		
1 MHz	0.540	3.250
3 MHz	0.920	4.400
10 MHz	1.650	5.900
20 MHz	2.300	8.300
30 MHz	2.800	10.200
40 MHz	3.200	11.800
50 MHz	3.600	13.200
100 MHz	5.100	18.700
200 MHz	7.200	26.400
400 MHz	-	-
500 MHz	11.400	41.700
700 MHz	13.500	49.400

Alternate Cable Options
Plenum, low smoke, high-temperature, and halogen-free bulk cable is also available upon request. For any other bulk cable needs or requests, please contact MilesTek.

TWC-124-2 cable PVC, 0.245 Inch Overall Diameter

xxx = cable length in inches
MP-2205-72 = 6 ft. (72 in.) MP-2205-xxx assembly



Connector	Part Number	1 Pc. Price	Connector
10-06030-210 straight 3-slot solder/clamp plug	MP-2205-xxx	\$116.50	10-06030-210 straight 3-slot solder/clamp plug



Connector	Part Number	1 Pc. Price	Connector
10-06030-210 straight 3-slot solder/clamp plug	MP-2302-xxx	\$51.06	blunt - no connector



Connector	Part Number	1 Pc. Price	Connector
10-06033-210 bend relief, straight 3-slot solder/clamp plug	MP-2152-xxx	\$100.04	10-06033-210 bend relief, straight 3-slot solder/clamp plug



Connector	Part Number	1 Pc. Price	Connector
10-06030-210 straight 3-slot solder/clamp plug	MP-2600-xxx	\$83.36	10-06575-210 straight 3-lug solder/clamp jack



Connector	Part Number	1 Pc. Price	Connector
10-06575-210 straight 3-lug solder/clamp jack	MP-2601-xxx	\$83.36	10-06575-210 straight 3-lug solder/clamp jack

Prices shown for 12" length. See our website for additional lengths.

TWC-124-1A cable PVC, 0.150 Inch Overall Diameter

xxx = cable length in inches
MP-2292-120 = 10 ft. (120 in.) MP-2292-xxx assembly



Connector	Part Number	1 Pc. Price	Connector
10-06030-231 straight 3-slot solder/clamp plug	MP-2292-xxx	\$125.36	10-06030-231 straight 3-slot solder/clamp plug



Connector	Part Number	1 Pc. Price	Connector
10-06030-231 straight 3-slot solder/clamp plug	MP-2602-xxx	\$56.27	blunt - no connector



Connector	Part Number	1 Pc. Price	Connector
10-06033-231 bend relief, straight 3-lug solder/clamp jack	MP-2487-xxx	\$104.20	10-06033-231 bend relief, straight 3-lug solder/clamp jack



Connector	Part Number	1 Pc. Price	Connector
10-10030-231 subminiature, straight 3-slot solder/clamp plug	MP-2603-xxx	\$93.78	10-10030-231 subminiature, straight 3-slot solder/clamp plug



Connector	Part Number	1 Pc. Price	Connector
10-10030-231 subminiature, straight 3-slot solder/clamp plug	MP-2344-xxx	\$88.57	10-06030-231 straight 3-slot solder/clamp plug

TRB Cable Plug - 3-Slot, Solder/Clamp

Compatible Twinax Cable Type	Plug	1 Pc. Price
TWC-124-2	10-06030-210	\$19.53
TWC-124-1A	10-06030-231	\$19.35
Specifications - Dimensions		Plug
overall body width - inches (mm)		0.57" (14.50)
overall body length - inches (mm)		1.12" (28.50)



TRB Cable Plug - 3-Slot, Bend Relief

Compatible Twinax Cable Type	Plug + Spring	1 Pc. Price
TWC-124-2	10-06033-210	\$25.52
TWC-124-1A	10-06033-231	\$24.30
Specifications - Dimensions		Jack + Spring
overall body width - inches (mm)		0.57" (14.50)
overall body length - inches (mm)		1.12" (28.50)
spring length - inches (mm)		1.85" (46.88)



TRB Cable Jack - 3-Lug, Solder/Clamp

Compatible Twinax Cable Type	Jack	1 Pc. Price
TWC-124-2	10-06575-210	\$29.28
TWC-124-1A	10-06575-231	\$29.01
Specifications - Dimensions		Jack
overall body width - inches (mm)		0.57" (14.50)
overall body length - inches (mm)		1.31" (33.40)



TRS Submin Plug - 3-Slot, Solder/Clamp

Compatible Twinax Cable Type	Plug	1 Pc. Price
TWC-124-1A	10-10030-231	\$28.72
Specifications - Dimensions		Plug
overall body width - inches (mm)		0.46" (11.68)
overall body length - inches (mm)		0.83" (21.08)



TWINAXIAL | 124 Ohm Twinax Assemblies



Plenum Cable Assemblies

Item #	Description	1 Pc. Price
MSA00160-12N	Plenum Cable Assembly TRB 3-Slot Plug to Plug .242" O.D. +125C 124 Ohm Twinaxial Shielded Twisted Pair 1'	\$97.21
MSA00161-12N	Plenum Cable Assembly TRB 3-Slot Plug to Blunt .242" O.D. +125C 124 Ohm Twinaxial Shielded Twisted Pair 1'	\$88.25
MSA00162-12N	Plenum Cable Assembly TRB 3-Slot Plug to 3-Lug Cable Jack .242" O.D. +125C 124 Ohm Twinaxial Shielded Twisted Pair 1'	\$104.92
MSA00163-12N	Plenum Cable Assembly TRB 3-Slot Plug to Non-Insulated Bulk Head 3-Lug Cable Jack .242" O.D. +125C 124 Ohm Twinaxial Shielded Twisted Pair 1'	\$106.33
MSA00164-12N	Plenum Cable Assembly TRB 3-Slot Plug to Insulated Bulk Head 3-Lug Cable Jack .242" O.D. +125C 124 Ohm Twinaxial Shielded Twisted Pair 1'	\$111.85
MSA00165-12N	Plenum Cable Assembly TRB 3-Slot Plug to Plug with Bend Reliefs .242" O.D. +125C 124 Ohm Twinaxial Shielded Twisted Pair 1'	\$99.71
MSA00166-12N	Plenum Cable Assembly TRB 3-Slot Plug with Bend Relief to Blunt .242" O.D. +125C 124 Ohm Twinaxial Shielded Twisted Pair 1'	\$92.78
MSA00167-12N	Plenum Cable Assembly TRB 3-Slot Plug to 3-Lug Cable Jack with Bend Reliefs .242" O.D. +125C 124 Ohm Twinaxial Shielded Twisted Pair 1'	\$112.32
MSA00168-12N	Plenum Cable Assembly TRB 3-Slot Plug to Non-Insulated Bulk Head 3-Lug Cable Jack with Bend Reliefs .242" O.D. +125C 124 Ohm Twinaxial Shielded Twisted Pair 1'	\$112.32
MSA00169-12N	Plenum Cable Assembly TRB 3-Slot Plug to Insulated Bulk Head 3-Lug Cable Jack with Bend Reliefs .242" O.D. +125C 124 Ohm Twinaxial Shielded Twisted Pair 1'	\$113.73
MSA00170-12N	Plenum Cable Assembly TRB 3-Lug Cable Jack to Jack .242" O.D. +125C 124 Ohm Twinaxial Shielded Twisted Pair 1'	\$108.83
MSA00171-12N	Plenum Cable Assembly TRB Non-Insulated Bulk Head 3-Lug Cable Jack to Jack .242" O.D. +125C 124 Ohm Twinaxial Shielded Twisted Pair 1'	\$112.95
MSA00172-12N	Plenum Cable Assembly TRB Insulated Bulk Head Jack 3-Lug Cable Jack to Jack .242" O.D. +125C 124 Ohm Twinaxial Shielded Twisted Pair 1'	\$124.04
MSA00173-12N	Plenum Cable Assembly TRB 3-Lug Cable Jack to Jack with Bend Reliefs .242" O.D. +125C 124 Ohm Twinaxial Shielded Twisted Pair 1'	\$115.81
MSA00174-12N	Plenum Cable Assembly TRB Non-Insulated Bulk Head 3-Lug Cable Jack to Jack with Bend Reliefs .242" O.D. +125C 124 Ohm Twinaxial Shielded Twisted Pair 1'	\$115.81
MSA00175-12N	Plenum Cable Assembly TRB Insulated Bulk Head 3-Lug Cable Jack to Jack with Bend Relief .242" O.D. +125C 124 Ohm Twinaxial Shielded Twisted Pair 1'	\$129.72

Prices shown for 12" length.

See our website, MilesTek.com to view all of our products.

Twinaxial Cable



Description

Twinax cable is a two-conductor, twisted, balanced wire line with a specific impedance and a shielding braid around both wires.

Technical Information

The twisting of the two balanced signal-carrying conductor wires cancels any random induced noise voltage pickup, giving protection against any low-frequency magnetic noise passing through the copper braid. Twinax cable is shielded, insulated from the twisted signal carrying conductors.

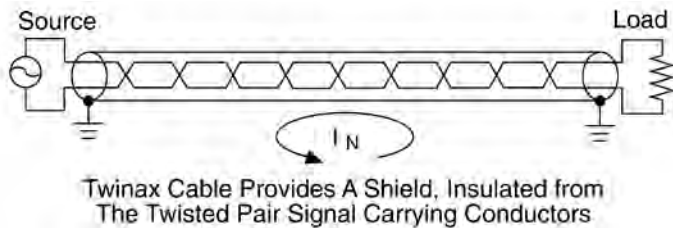

MilesTek's twinax cable design lowers cable losses by adding two dielectric fillers under the braid (separating the braid away from the signal pair), thereby lowering the leakage capacitance to ground. The coverage is improved to up to 93% by using more copper wire in the braid and weaving it tighter. This design also provides protection against ground loops and capacitive fields.

Applications

Twinax cables are a cost-efficient and effective option for short-range, high-speed, differential signaling applications. For this reason, twinax is best suited for low-frequency digital and video distribution systems, like connecting MIL-STD-1553 bus and stub devices. Twinax cable is most effective up to approximately 15 MHz, since it has higher transmission losses above this frequency.



Triaxial Cable

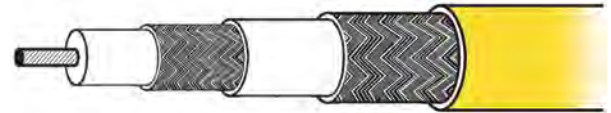

Description

Triax cable is coax cable with an additional outer copper braid (insulated from the signal carrying conductors) which acts as a shield protecting the enclosed coax conductors.

Technical Information

The outer braid is grounded and passes both ground loop and capacitive field noise currents away from the signal-carrying coax. This greatly improves the "signal-to-noise" ratio when compared to standard coax cable. In essence, triax cable provides additional shielding, insulated from the signal carrying coax.

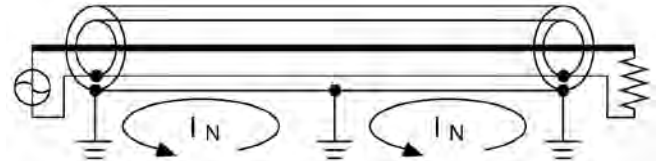

Driven Shield

Triax cable is also used in "Driven Shield" (see diagram below) applications, where the inner conductor and the inner braid are driven in parallel at the transmitting end, and work against the outer braid which is insulated above ground. The inner braid creates a "Faraday" shield between the inner conductor and outer braid, as it is floating at the receiving end. Thus, the cable's distributed capacitance, cable losses and loading are greatly reduced.

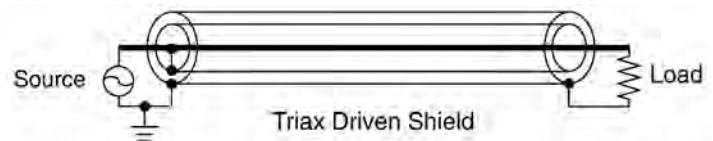

Applications

Triax cables are effective for a broad range of applications, including high-frequency transducer data systems (where the distributed capacity in coax cable limits the data accuracy) and precision low-current measurements. Also, the two braids are useful as a low-impedance transmission line (approximately 12 ohms) to carry high-current pulses to low-impedance laser lamps or exploding bridge wire (EBW) ordinance systems.

TRIAXIAL | 50 & 75 Ohm Triax Cable



TRC-50-2
assemblies page 35



TRC-50-1
assemblies page 35



TRC-75-2
assemblies page 38



TRC-75-1
assemblies page 38

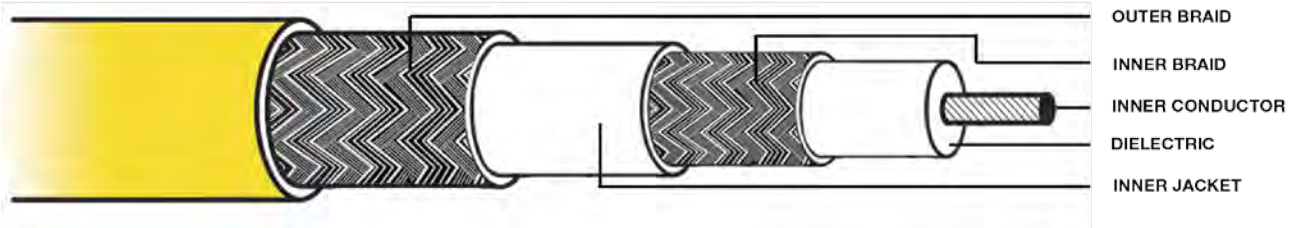

MilesTek	50 Ohm Triaxial Cable		75 Ohm Triaxial Cable	
Cable Type Part Number	TRC-50-2	TRC-50-1	TRC-75-2	TRC-75-1
Price Per Foot	\$3.32	\$3.32	\$3.32	\$3.43
uses MilesTek connector	-310	-370	-310	-350
Specifications				
nominal impedance (ohms)	50 ± 2	50 ± 2	75 ± 5	75 ± 5
nominal outer diameter (inches)	0.242	0.156	0.245	0.189
conductor diameter (inches)	0.037	0.015	0.185	0.012
max. operating VDC	6.0 kV	2.0 kV	6.0 kV	2.0 kV
max. operating VAC (RMS)	2.0 kV	1.0 kV	2.0 kV	1.0 kV
minimum bend radius (inches)	1.25	0.75	1.25	1.00
nominal capacitance (pF/ft.)	32.00	29.50	20.50	20.00
outer jacket material	PVC	PVC	PVC	PVC
insulation material	PVC	PVC	PVC	PVC
shield coverage	93%	93%	93%	93%
Attenuation (dB/100 ft.)				
1 MHz	0.500	2.800	0.480	0.900
3 MHz	0.800	3.100	0.880	1.300
10 MHz	1.500	4.100	1.500	2.400
20 MHz	2.300	5.500	2.300	3.600
30 MHz	2.900	7.000	2.900	4.500
40 MHz	3.400	7.500	3.300	5.400
50 MHz	3.900	9.100	3.600	6.100
100 MHz	5.800	14.000	5.200	9.700
200 MHz	8.800	22.000	7.600	16.500
400 MHz	-	-	-	-
500 MHz	15.300	40.000	10.800	28.500
700 MHz	18.000	50.000	14.700	36.000

TRC-50-2 Cable PVC, 0.242 Inch Overall Diameter

xxx = cable length in inches
CA-3017-72 = 6 ft. (72 in.) CA-3017-xxx assembly



Connector	Part Number	1 Pc. Price	Connector
10-06030-310 straight 3-slot solder/clamp plug	CA-3017-xxx	\$135.47	10-06030-310 straight 3-slot solder/clamp plug



Connector	Part Number	1 Pc. Price	Connector
10-06030-310 straight 3-slot solder/clamp plug	MP-2604-xxx	\$106.29	blunt - no connector



Connector	Part Number	1 Pc. Price	Connector
10-06033-310 bend relief, straight 3-slot solder/clamp plug	MP-2605-xxx	\$130.25	10-06033-310 bend relief, straight 3-slot solder/clamp plug



Connector	Part Number	1 Pc. Price	Connector
10-06030-310 straight 3-slot solder/clamp plug	MP-2606-xxx	\$165.86	10-06575-310 straight 3-lug solder/clamp jack



Connector	Part Number	1 Pc. Price	Connector
10-06575-310 straight 3-lug solder/clamp jack	MP-2607-xxx	\$162.56	10-06575-310 straight 3-lug solder/clamp jack

TRC-50-1 Cable PVC, 0.156 Inch Overall Diameter

xxx = cable length in inches
MP-2346-120 = 10 ft. (120 in.) MP-2346-xxx assembly



Connector	Part Number	1 Pc. Price	Connector
10-06030-370 straight 3-slot solder/clamp plug	MP-2346-xxx	\$138.83	10-06030-370 straight 3-slot solder/clamp plug



Connector	Part Number	1 Pc. Price	Connector
10-06030-370 straight 3-slot solder/clamp plug	MP-2608-xxx	\$84.41	blunt - no connector



Connector	Part Number	1 Pc. Price	Connector
10-06030-370 straight 3-slot solder/clamp plug	MP-2609-xxx	\$140.67	10-06575-370 straight 3-lug solder/clamp jack



Connector	Part Number	1 Pc. Price	Connector
10-10030-370 subminiature, straight 3-slot solder/clamp plug	MP-2610-xxx	\$140.67	10-10030-370 subminiature, straight 3-slot solder/clamp plug



Connector	Part Number	1 Pc. Price	Connector
10-10030-370 subminiature, straight 3-slot solder/clamp plug	MP-2611-xxx	\$163.65	10-06030-370 straight 3-slot solder/clamp plug

Prices shown for 12" length. See our website for additional lengths.

TRB Cable Plug - 3-Slot, Solder/Clamp

Compatible Triax Cable Type	Plug	1 Pc. Price
TRC-50-2	10-06030-310	\$18.78
TRC-50-1	10-06030-370	\$18.78
Specifications - Dimensions	Plug	
overall body width - inches (mm)	0.57" (14.50)	
overall body length - inches (mm)	1.12" (28.50)	



TRS Submin Plug - 3-Slot, Solder/Clamp

Compatible Triax Cable Type	Plug	1 Pc. Price
TRC-50-1	10-10030-370	\$28.72
Specifications - Dimensions	Plug	
overall body width - inches (mm)	0.46" (11.68)	
overall body length - inches (mm)	0.83" (21.08)	



TRIAXIAL | 50 Ohm Triax Assemblies



Halogen Free Cable Assemblies

Item #	Description	1 Pc. Price
MSA00288-12N	Halogen Free Cable Assembly with TRB 3-Slot Plug to Plug .245" O.D. -30C +80C 50 Ohm Triaxial Yellow 1'	\$128.59
MSA00289-12N	Halogen Free Cable Assembly TRB 3-Slot Plug to Blunt .245" O.D. -30C +80C 50 Ohm Triaxial Yellow 1'	\$117.13
MSA00290-12N	Halogen Free Cable Assembly TRB 3-Slot Plug to 3-Lug Cable Jack .245" O.D. -30C +80C 50 Ohm Triaxial Yellow 1'	\$145.26
MSA00291-12N	Halogen Free Cable Assembly TRB 3-Slot Plug to Non-Insulated Bulk Head 3-Lug Cable Jack .245" O.D. -30C +80C 50 Ohm Triaxial Yellow 1'	\$146.67
MSA00292-12N	Halogen Free Cable Assembly TRB 3-Slot Plug to Insulated Bulk Head 3-Lug Cable Jack .245" O.D. -30C +80C 50 Ohm Triaxial Yellow 1'	\$152.24
MSA00293-12N	Halogen Free Cable Assembly TRB 3-Slot Plug to Plug with Bend Reliefs .245" O.D. -30C +80C 50 Ohm Triaxial Yellow 1'	\$134.27
MSA00294-12N	Halogen Free Cable Assembly TRB 3-Slot Plug with Bend Relief to Blunt .245" O.D. -30C +80C 50 Ohm Triaxial Yellow 1'	\$119.99
MSA00295-12N	Halogen Free Cable Assembly TRB 3-Slot Plug to 3-Lug Cable Jack with Bend Reliefs .245" O.D. -30C +80C 50 Ohm Triaxial Yellow 1'	\$150.94
MSA00296-12N	Halogen Free Cable Assembly TRB 3-Slot Plug to Non-Insulated Bulk Head 3-Lug Cable Jack with Bend Reliefs .245" O.D. -30C +80C 50 Ohm Triaxial Yellow 1'	\$150.99
MSA00297-12N	Halogen Free Cable Assembly TRB 3-Slot Plug to Insulated Bulk Head 3-Lug Cable Jack with Bend Reliefs .245" O.D. -30C +80C 50 Ohm Triaxial Yellow 1'	\$157.92
MSA00298-12N	Halogen Free Cable Assembly TRB 3-Lug Cable Jack to Jack .245" O.D. -30C +80C 50 Ohm Triaxial Yellow 1'	\$161.93
MSA00299-12N	Halogen Free Cable Assembly TRB Non-Insulated Bulk Head 3-Lug Cable Jack to Jack .245" O.D. -30C +80C 50 Ohm Triaxial Yellow 1'	\$162.24
MSA00300-12N	Halogen Free Cable Assembly TRB Insulated Bulk Head Jack 3-Lug Cable Jack to Jack .245" O.D. -30C +80C 50 Ohm Triaxial Yellow 1'	\$142.08
MSA00301-12N	Halogen Free Cable Assembly TRB 3-Lug Cable Jack to Jack with Bend Reliefs .245" O.D. -30C +80C 50 Ohm Triaxial Yellow 1'	\$136.35
MSA00302-12N	Halogen Free Cable Assembly TRB Non-Insulated Bulk Head 3-Lug Cable Jack to Jack with Bend Reliefs .245" O.D. -30C +80C 50 Ohm Triaxial Yellow 1'	\$136.66
MSA00303-12N	Halogen Free Cable Assembly TRB Insulated Bulk Head 3-Lug Cable Jack to Jack with Bend Relief .245" O.D. -30C +80C 50 Ohm Triaxial Yellow 1'	\$147.76

Prices shown for 12" length.

See our website, MilesTek.com to view all of our products.

MilesTek

an INFINIT® brand

Teflon Jacket Cable Assemblies

Item #	Description	1 Pc. Price
MSA00352-12N	Teflon Jacket Cable Assembly with TRB 3-Slot Plug to Plug .236" O.D. -55C +200C 50 Ohm Triaxial 1'	\$156.51
MSA00353-12N	Teflon Jacket Cable Assembly TRB 3-Slot Plug to Blunt .236" O.D. -55C +200C 50 Ohm Triaxial 1'	\$129.42
MSA00354-12N	Teflon Jacket Cable Assembly TRB 3-Slot Plug to 3-Lug Cable Jack .236" O.D. -55C +200C 50 Ohm Triaxial 1'	\$173.19
MSA00355-12N	Teflon Jacket Cable Assembly TRB 3-Slot Plug to Non-Insulated Bulk Head 3-Lug Cable Jack .236" O.D. -55C +200C 50 Ohm Triaxial 1'	\$174.59
MSA00356-12N	Teflon Jacket Cable Assembly TRB 3-Slot Plug to Insulated Bulk Head 3-Lug Cable Jack .236" O.D. -55C +200C 50 Ohm Triaxial 1'	\$173.91
MSA00357-12N	Teflon Jacket Cable Assembly TRB 3-Slot Plug to Plug with Bend Reliefs .236" O.D. -55C +200C 50 Ohm Triaxial 1'	\$131.14
MSA00358-12N	Teflon Jacket Cable Assembly TRB 3-Slot Plug with Bend Relief to Blunt .236" O.D. -55C +200C 50 Ohm Triaxial 1'	\$147.92
MSA00359-12N	Teflon Jacket Cable Assembly TRB 3-Slot Plug to 3-Lug Cable Jack with Bend Reliefs .236" O.D. -55C +200C 50 Ohm Triaxial 1'	\$178.86
MSA00360-12N	Teflon Jacket Cable Assembly TRB 3-Slot Plug to Non-Insulated Bulk Head 3-Lug Cable Jack with Bend Reliefs .236" O.D. -55C +200C 50 Ohm Triaxial 1'	\$180.27
MSA00361-12N	Teflon Jacket Cable Assembly TRB 3-Slot Plug to Insulated Bulk Head 3-Lug Cable Jack with Bend Reliefs .236" O.D. -55C +200C 50 Ohm Triaxial 1'	\$182.98
MSA00362-12N	Teflon Jacket Cable Assembly TRB 3-Lug Cable Jack to Jack .236" O.D. -55C +200C 50 Ohm Triaxial 1'	\$189.86
MSA00363-12N	Teflon Jacket Cable Assembly TRB Non-Insulated Bulk Head 3-Lug Cable Jack to Jack .236" O.D. -55C +200C 50 Ohm Triaxial 1'	\$192.88
MSA00364-12N	Teflon Jacket Cable Assembly TRB Insulated Bulk Head Jack 3-Lug Cable Jack to Jack .236" O.D. -55C +200C 50 Ohm Triaxial 1'	\$203.77
MSA00365-12N	Teflon Jacket Cable Assembly TRB 3-Lug Cable Jack to Jack with Bend Reliefs .236" O.D. -55C +200C 50 Ohm Triaxial 1'	\$195.54
MSA00366-12N	Teflon Jacket Cable Assembly TRB Non-Insulated Bulk Head 3-Lug Cable Jack to Jack with Bend Reliefs .236" O.D. -55C +200C 50 Ohm Triaxial 1'	\$198.35
MSA00367-12N	Teflon Jacket Cable Assembly TRB Insulated Bulk Head 3-Lug Cable Jack to Jack with Bend Relief .236" O.D. 55C +200C 50 Ohm Triaxial 1'	\$209.45

Assembly prices shown for 12" length.

See our website, MilesTek.com to view all of our products.



TRIAXIAL | 75 Ohm Triax Assemblies

TRC-75-2 Cable

Pvc, 0.245 Inch Overall Diameter

xxx = cable length in inches

CA-3013-72 = 6 ft. (72 in.) CA-3013-xxx assembly



Connector	Part Number	1 Pc. Price	Connector
10-06030-310 straight 3-slot solder/ clamp plug	CA-3013-xxx	\$109.37	10-06030-310 straight 3-slot solder/clamp plug



Connector	Part Number	1 Pc. Price	Connector
10-06030-310 straight 3-slot solder/clamp plug	MP-2612-xxx	\$92.74	blunt - no connector



Connector	Part Number	1 Pc. Price	Connector
10-06030-310 bend relief, straight 3-slot solder/clamp plug	MP-2613-xxx	\$140.67	10-06030-310 bend relief, straight 3-slot solder/clamp plug



Connector	Part Number	1 Pc. Price	Connector
10-06030-310 straight 3-slot solder/clamp plug	MP-2614-xxx	\$118.79	10-06575-310 straight 3-slot solder/clamp jack



Connector	Part Number	1 Pc. Price	Connector
10-06575-310 straight 3-lug solder/clamp jack	MP-2615-xxx	\$130.25	10-06575-310 straight 3-lug solder/clamp jack

TRC-75-1 Cable

Pvc, 0.189 Inch Overall Diameter

xxx = cable length in inches

MP-3000-120 = 10 ft. (120 in.) MP-3000-xxx assembly



Connector	Part Number	1 Pc. Price	Connector
10-06030-350 straight 3-slot solder/clamp plug	MP-3000-xxx	\$140.67	10-06030-350 straight 3-slot solder/clamp plug



Connector	Part Number	1 Pc. Price	Connector
10-06030-350 straight 3-slot solder/clamp plug	MP-2616-xxx	\$104.08	blunt - no connector



Connector	Part Number	1 Pc. Price	Connector
10-06030-350 straight 3-slot solder/clamp plug	MP-2617-xxx	\$231.39	10-06575-350 straight 3-slot solder/clamp jack



Connector	Part Number	1 Pc. Price	Connector
10-10030-350 subminiature, straight 3-slot solder/clamp plug	MP-2618-xxx	\$145.88	10-10030-350 subminiature 3-slot solder/clamp plug



Connector	Part Number	1 Pc. Price	Connector
10-10030-350 subminiature, straight 3-slot solder/clamp plug	MP-2619-xxx	\$147.71	10-06030-350 straight 3-slot solder/clamp plug

Prices shown for 12" length. See our website for additional lengths.

TRB Cable Plug - 3-Slot, Solder/Clamp

Compatible Triax Cable Type	Plug	1 Pc. Price
TRC-75-2	10-06030-310	\$18.78
TRC-75-1	10-06030-350	\$18.78
Specifications - Dimensions	Plug	
overall body width - inches (mm)	0.57" (14.50)	
overall body length - inches (mm)	1.12" (28.50)	



TRS Submin Plug - 3-Slot, Solder/Clamp

Compatible Triax Cable Type	Plug	1 Pc. Price
TRC-75-1	10-10030-350	\$28.72
Specifications - Dimensions	Plug	
overall body width - inches (mm)	0.46" (11.68)	
overall body length - inches (mm)	0.83" (21.08)	



LSZH Cable Assemblies

Item #	Description	1 Pc. Price
DSA00001-1F	LSZH D-Sub Cable, DB9 Male / DB9 Male	\$33.09
DSA00002-1F	LSZH D-Sub Cable, DB9 Male / DB9 Female	\$33.09
DSA00004-1F	LSZH D-Sub Cable, DB15 Male / DB15 Male	\$34.96
DSA00005-1F	LSZH D-Sub Cable, DB15 Male / DB15 Female	\$34.96
DSA00006-1F	LSZH D-Sub Cable, DB25 Male / DB25 Male	\$38.77
DSA00007-1F	LSZH D-Sub Cable, DB25 Male / DB25 Female	\$38.77

Prices shown for 1F length. See our website for additional lengths.

Field Termination Connectors

Item #	Description	1 Pc. Price
DSB00001	SVGA HD15 Jack for Field Termination	\$14.75
DSB00003	SVGA HD15 Plug for Field Termination	\$17.25
DSB00005	Mini Din 4 Female Field Termination Connector	\$14.70
DSB00006	DVI-D Dual Link Field Termination Connector	\$19.60
DSB00007	Female Field Termination Connector for HDMI Applications	\$14.50
DSB00008	3.5mm Field Termination Connector Female	\$7.50
DSB00106	DB9 Female Connector for Field Termination	\$11.00
DSB00108	DB15 Female Connector for Field Termination	\$13.50
DSB00110	HD15 Female Connector for Field Termination Panel Mount	\$14.75
DSB00114	DB9 Male Connector for Field Termination	\$11.10
DSB00116	DB15 Male Connector for Field Termination	\$14.65
DSB00118	HD15 Male Connector for Field Termination	\$14.65
DSB00123	DB15 Female Connector with Screwless Terminal Block	\$16.20
DSB00124	DB25 Female Connector with Screwless Terminal Block	\$20.05

D-Sub Bulk Packaged Connectors - Crimp Style

Item #	Description	1 Pc. Price
DSB00021	DB9 Male Crimp Connectors Tray, 50	\$32.10
DSB00022	DB15 Male Crimp Connectors Tray, 50	\$35.75
DSB00023	DB15 Female Crimp Connectors Tray, 50	\$39.00
DSB00024	DB25 Male Crimp Connectors Tray, 50	\$40.10
DSB00025	DB25 Female Crimp Connectors Tray, 50	\$43.35
DSB00026	DB37 Male Crimp Connectors Tray, 40	\$85.40
DSB00029	HD26 Male Solder Connectors Tray, 70	\$187.20

D-Sub Bulk Packaged Connectors - Solder Style

Item #	Description	1 Pc. Price
DSB00011	DB9 Male Solder Connectors Tray, 50	\$51.68
DSB00012	DB9 Female Solder Connectors Tray, 50	\$52.53
DSB00013	DB15 Male Solder Connectors Tray, 70	\$82.80
DSB00014	DB15 Female Solder Connectors Tray, 70	\$84.90
DSB00015	DB25 Male Solder Connectors Tray, 50	\$69.75
DSB00016	DB25 Female Solder Connectors Tray, 50	\$71.90
DSB00028	HD15 Female Solder Connectors Tray, 50	\$84.15
DSB00030	HD26 Female Solder Connectors Tray, 70	\$197.50



DSA00002-F



DSA00005-F



DSA00007-F

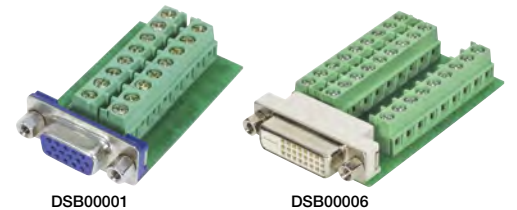

DSB00001

DSB00006

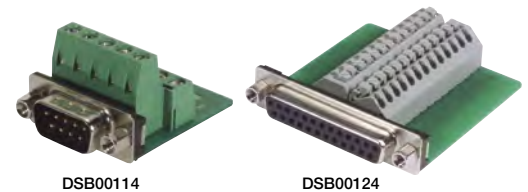

DSB00114

DSB00124



DSB00021

DSB00012



DSB00015

DSB00030

See our website, MilesTek.com to view all of our products.

ETHERNET | Category 5e, 6, 6a Cable Assemblies



T5A - Category 5e Cables

Item #	Description	1 Pc. Price
T5A00001-1F	Double Shielded 24 AWG Solid Category 5e LSZH Patch Cord, Gray	\$17.51
T5A00002-1F	Double Shielded 24 AWG Solid Category 5e LSZH Patch Cord, Black	\$17.51
T5A00003-1F	Double Shielded 24 AWG Solid Category 5e LSZH Patch Cord, Red	\$17.51
T5A00005-1F	Double Shielded 26 AWG Stranded Category 5e LSZH Patch Cord, Gray	\$15.53
T5A00006-1F	Double Shielded 26 AWG Stranded Category 5e LSZH Patch Cord, Black	\$15.53
T5A00007-1F	Double Shielded 26 AWG Stranded Category 5e LSZH Patch Cord, Red	\$15.53
T5A00008-1F	Shielded Category 5e Low Smoke Zero Halogen Cable, RJ45 M / M, Black	\$14.91
T5A00010-1F	Shielded Category 5e Extreme High Flex Ethernet Cable, RJ45 / RJ45, Teal	\$46.63
T5A00004-1M	Category 5e GigE Double Shielded Armored Ethernet Cable, GigE / GigE, 1.0m	\$45.28
T5A00013-1M	Category 5e GigE Double Shielded High Flex Ethernet Cable, GigE / RJ45	\$21.52
T5A00016-1M	Category 5e GigE Double Shielded High Flex Ethernet Cable, GigE / GigE	\$22.88
T5A00017-1F	Category 5e Aerospace Ethernet Cable High-Temp SF/UTP FEP, Blue, Slim RJ45	\$38.19
T5A00018-1F	Category 5e Aerospace Ethernet Cable High-Temp SF/UTP FEP, Blue RJ45	\$35.19
T5A00019-1M	Category 5e RJ45 IP67 Rated Dual Use Outdoor Cable, Black	\$23.92
T5A00020-1F	Category 5e EIA568 Plenum Patch Cable, RJ45 / RJ45, Gray	\$13.71
T5A00015-1M	IP68 Cat5e Cable, Rugged RJ45, Plug to Plug, ZnNi Finish w/ FR-TPE Cable & Dust Caps	\$392.21

Assembly prices shown for 1.0m (1.0ft.) length. See our website for additional lengths.

T6A - Category 6 Cables

Item #	Description	1 Pc. Price
T6A00001-1F	Double Shielded LSZH 26 AWG Stranded Cat 6 RJ45 / RJ45 Patch Cord, Black	\$17.04
T6A00002-1F	Double Shielded LSZH 26 AWG Stranded Cat 6 RJ45 / RJ45 Patch Cord, Gray	\$17.04
T6A00003-1F	Double Shielded LSZH 26 AWG Stranded Cat 6 RJ45 / RJ45 Patch Cord, Red	\$17.04
T6A00004-1F	Shielded Category 6 Cable, RJ45 / RJ45 LSZH Jacket, Gray	\$12.72
T6A00005-1F	Shielded Category 6 Cable, RJ45 / RJ45 LSZH Jacket, Black	\$12.56
T6A00006-1F	Shielded Category 6 Cable, RJ45 / RJ45 LSZH Jacket, Red	\$12.56
T6A00008-1M	Category 6 RJ45 IP67 Rated Dual Use Outdoor Cable, Black	\$27.04
T6A00009-1F	Category 6 LSZH Patch Cable, RJ45 / RJ45, Blue	\$11.46

Assembly prices shown for 1.0ft. (1.0m) length. See our website for additional lengths.

TAA - Category 6a Cables

Item #	Description	1 Pc. Price
TAA00001-1M	Category 6a GigE Double Shielded High Flex Ethernet Cable, GigE / GigE	\$26.52
TAA00002-1M	Category 6a GigE Double Shielded High Flex Ethernet Cable, GigE / RJ45	\$24.86
TAA00003-1F	Category 6a Shielded LSZH Ethernet Cable RJ45 / RJ45, Red	\$36.43
TAA00004-1F	Category 6a Shielded LSZH Ethernet Cable RJ45 / RJ45, Black	\$36.43
TAA00005-1F	Category 6a Shielded LSZH Ethernet Cable RJ45 / RJ45, Blue	\$36.43
T6A00007-1F	Category 6a Aerospace Ethernet Cable High-Temp SF/UTP FEP, Blue RJ45	\$39.25

Assembly prices shown for 1.0m (1.0ft.) length. See our website for additional lengths.

T5A - Category 5e M12 4 Position D code Industrial Cables

Item #	Description	1 Pc. Price
T5A00009-1M	Category 5e M12 4 Position D Code Double Shielded Industrial Cable, M12 M / M12 M, 1.0m	\$37.99
T5A00011-1M	Category 5e M12 4 Position D code Double Shielded Industrial Cable, M12 M / M12 F, 1.0m	\$39.03
T5A00012-1M	Category 5e M12 4 Position D code Double Shielded Industrial Cable, M12 M / RJ45, 1.0m	\$30.69
T5A00014-1M	Category 5e M12 4 Position D code Double Shielded Industrial Cable, M12 F / RJ45, 1.0m	\$31.73
T5A00022-1M	Category 5e M12 4 Position D code Double Shielded Industrial Cable, Right Angle M12 M / M12 M, 1.0m	\$39.03
T5A00022-2M	Category 5e M12 4 Position D code Double Shielded Industrial Cable, Right Angle M12 M / M12 M, 2.0m	\$50.49
T5A00022-3M	Category 5e M12 4 Position D code Double Shielded Industrial Cable, Right Angle M12 M / M12 M, 3.0m	\$60.91
T5A00022-5M	Category 5e M12 4 Position D code Double Shielded Industrial Cable, Right Angle M12 M / M12 M, 5.0m	\$73.41
T5A00022-10M	Category 5e M12 4 Position D code Double Shielded Industrial Cable, Right Angle M12 M / M12 M, 10.0m	\$123.43
T5A00022-15M	Category 5e M12 4 Position D code Double Shielded Industrial Cable, Right Angle M12 M / M12 M, 15.0m	\$161.98
T5A00023-1M	Category 5e M12 4 Position D code SF/UTP Industrial Cable, Right Angle M12 M / RJ45, 1.0m	\$31.73
T5A00023-2M	Category 5e M12 4 Position D code SF/UTP Industrial Cable, Right Angle M12 M / RJ45, 2.0m	\$44.24
T5A00023-3M	Category 5e M12 4 Position D code SF/UTP Industrial Cable, Right Angle M12 M / RJ45, 3.0m	\$55.70
T5A00023-5M	Category 5e M12 4 Position D code SF/UTP Industrial Cable, Right Angle M12 M / RJ45, 5.0m	\$67.16
T5A00023-10M	Category 5e M12 4 Position D code SF/UTP Industrial Cable, Right Angle M12 M / RJ45, 10.0m	\$118.22
T5A00023-15M	Category 5e M12 4 Position D code SF/UTP Industrial Cable, Right Angle M12 M / RJ45, 15.0m	\$154.17
T5A00024-1M	Category 5e M12 4 Position D code Armored Double Shielded Industrial Cable, M12 M / M12 F, 1.0m	\$50.67
T5A00024-2M	Category 5e M12 4 Position D code Armored Double Shielded Industrial Cable, M12 M / M12 F, 2.0m	\$68.00
T5A00024-3M	Category 5e M12 4 Position D code Armored Double Shielded Industrial Cable, M12 M / M12 F, 3.0m	\$85.79
T5A00024-5M	Category 5e M12 4 Position D code Armored Double Shielded Industrial Cable, M12 M / M12 F, 5.0m	\$122.97
T5A00024-10M	Category 5e M12 4 Position D code Armored Double Shielded Industrial Cable, M12 M / M12 F, 10.0m	\$209.20

Some assembly prices shown for 1.0m length. See our website for additional lengths.



TAA - Category 6a M12 8 Position X code Industrial Cables

Item #	Description	1 Pc. Price
TAA00009-1M	Category 6a M12 8 Position X code Double Shielded Industrial Cable, M12 M / GigE, 1.0m	\$66.14
TAA00009-2M	Category 6a M12 8 Position X code Double Shielded Industrial Cable, M12 M / GigE, 2.0m	\$79.81
TAA00009-3M	Category 6a M12 8 Position X code Double Shielded Industrial Cable, M12 M / GigE, 3.0m	\$92.10
TAA00009-5M	Category 6a M12 8 Position X code Double Shielded Industrial Cable, M12 M / GigE, 5.0m	\$120.20
TAA00009-10M	Category 6a M12 8 Position X code Double Shielded Industrial Cable, M12 M / GigE, 10.0m	\$186.36
TAA00010-1M	Category 6a M12 8 Position X code SF/UTP Industrial Cable, M12 M / RJ45, 1.0m	\$61.59
TAA00010-2M	Category 6a M12 8 Position X code SF/UTP Industrial Cable, M12 M / RJ45, 2.0m	\$74.58
TAA00010-3M	Category 6a M12 8 Position X code SF/UTP Industrial Cable, M12 M / RJ45, 3.0m	\$87.60
TAA00010-5M	Category 6a M12 8 Position X code SF/UTP Industrial Cable, M12 M / RJ45, 5.0m	\$113.60
TAA00010-10M	Category 6a M12 8 Position X code SF/UTP Industrial Cable, M12 M / RJ45, 10.0m	\$220.96
TAA00011-1M	Category 6a M12 8 Position X code Double Shielded Industrial Cable, M12 M / M12 M, 1.0m	\$104.41
TAA00011-2M	Category 6a M12 8 Position X code Double Shielded Industrial Cable, M12 M / M12 M, 2.0m	\$117.37
TAA00011-3M	Category 6a M12 8 Position X code Double Shielded Industrial Cable, M12 M / M12 M, 3.0m	\$130.35
TAA00011-5M	Category 6a M12 8 Position X code Double Shielded Industrial Cable, M12 M / M12 M, 5.0m	\$155.03
TAA00011-10M	Category 6a M12 8 Position X code Double Shielded Industrial Cable, M12 M / M12 M, 10.0m	\$220.96
TAA00012-05M	Category 6a M12 8 Position X code SF/UTP Industrial Cable, M12 M / M12 F Panel Mount, 0.5m	\$90.58
TAA00012-1M	Category 6a M12 8 Position X code SF/UTP Industrial Cable, M12 M / M12 F Panel Mount, 1.0m	\$97.05
TAA00012-2M	Category 6a M12 8 Position X code SF/UTP Industrial Cable, M12 M / M12 F Panel Mount, 2.0m	\$109.96
TAA00012-3M	Category 6a M12 8 Position X code SF/UTP Industrial Cable, M12 M / M12 F Panel Mount, 3.0m	\$122.95
TAA00012-5M	Category 6a M12 8 Position X code SF/UTP Industrial Cable, M12 M / M12 F Panel Mount, 5.0m	\$147.64
TAA00012-10M	Category 6a M12 8 Position X code SF/UTP Industrial Cable, M12 M / M12 F Panel Mount, 10.0m	\$213.57
TAA00013-1M	Category 6a M12 8 Position X code SF/UTP Industrial Cable, M12 M / M12 F, 1.0m	\$105.46
TAA00013-2M	Category 6a M12 8 Position X code SF/UTP Industrial Cable, M12 M / M12 F, 2.0m	\$118.39
TAA00013-3M	Category 6a M12 8 Position X code SF/UTP Industrial Cable, M12 M / M12 F, 3.0m	\$131.35
TAA00013-5M	Category 6a M12 8 Position X code SF/UTP Industrial Cable, M12 M / M12 F, 5.0m	\$156.06
TAA00013-10M	Category 6a M12 8 Position X code SF/UTP Industrial Cable, M12 M / M12 F, 10.0m	\$221.99

ETHERNET | Category 6a Assemblies/M12 Connectors

TAA - Category 6a Plenum Rated Shielded Cables

Item #	Description	1 Pc. Price
TAA00006-1F	Plenum Rated Shielded Category 6a Cable, RJ45 / RJ45, 23AWG Solid, Blue, 1.0ft	\$20.17
TAA00006-2F	Plenum Rated Shielded Category 6a Cable, RJ45 / RJ45, 23AWG Solid, Blue, 2.0ft	\$21.43
TAA00006-3F	Plenum Rated Shielded Category 6a Cable, RJ45 / RJ45, 23AWG Solid, Blue, 3.0ft	\$22.70
TAA00006-5F	Plenum Rated Shielded Category 6a Cable, RJ45 / RJ45, 23AWG Solid, Blue, 5.0ft	\$25.23
TAA00006-7F	Plenum Rated Shielded Category 6a Cable, RJ45 / RJ45, 23AWG Solid, Blue, 7.0ft	\$27.77
TAA00006-10F	Plenum Rated Shielded Category 6a Cable, RJ45 / RJ45, 23AWG Solid, Blue, 10.0ft	\$31.57
TAA00006-15F	Plenum Rated Shielded Category 6a Cable, RJ45 / RJ45, 23AWG Solid, Blue, 15.0ft	\$37.90
TAA00006-20F	Plenum Rated Shielded Category 6a Cable, RJ45 / RJ45, 23AWG Solid, Blue, 20.0ft	\$44.23
TAA00006-25F	Plenum Rated Shielded Category 6a Cable, RJ45 / RJ45, 23AWG Solid, Blue, 25.0ft	\$50.57
TAA00006-30F	Plenum Rated Shielded Category 6a Cable, RJ45 / RJ45, 23AWG Solid, Blue, 30.0ft	\$56.90
TAA00006-50F	Plenum Rated Shielded Category 6a Cable, RJ45 / RJ45, 23AWG Solid, Blue, 50.0ft	\$82.23
TAA00006-75F	Plenum Rated Shielded Category 6a Cable, RJ45 / RJ45, 23AWG Solid, Blue, 75.0ft	\$113.90
TAA00006-100F	Plenum Rated Shielded Category 6a Cable, RJ45 / RJ45, 23AWG Solid, Blue, 100.0ft	\$145.57
TAA00007-1F	Plenum Rated Shielded Category 6a Cable, RJ45 / RJ45, 23AWG Solid, White, 1.0ft	\$20.17
TAA00007-2F	Plenum Rated Shielded Category 6a Cable, RJ45 / RJ45, 23AWG Solid, White, 2.0ft	\$21.43
TAA00007-3F	Plenum Rated Shielded Category 6a Cable, RJ45 / RJ45, 23AWG Solid, White, 3.0ft	\$22.70
TAA00007-5F	Plenum Rated Shielded Category 6a Cable, RJ45 / RJ45, 23AWG Solid, White, 5.0ft	\$25.23
TAA00007-7F	Plenum Rated Shielded Category 6a Cable, RJ45 / RJ45, 23AWG Solid, White, 7.0ft	\$27.77
TAA00007-10F	Plenum Rated Shielded Category 6a Cable, RJ45 / RJ45, 23AWG Solid, White, 10.0ft	\$31.57
TAA00007-15F	Plenum Rated Shielded Category 6a Cable, RJ45 / RJ45, 23AWG Solid, White, 15.0ft	\$37.90
TAA00007-20F	Plenum Rated Shielded Category 6a Cable, RJ45 / RJ45, 23AWG Solid, White, 20.0ft	\$44.23
TAA00007-25F	Plenum Rated Shielded Category 6a Cable, RJ45 / RJ45, 23AWG Solid, White, 25.0ft	\$50.57
TAA00007-30F	Plenum Rated Shielded Category 6a Cable, RJ45 / RJ45, 23AWG Solid, White, 30.0ft	\$56.90
TAA00007-50F	Plenum Rated Shielded Category 6a Cable, RJ45 / RJ45, 23AWG Solid, White, 50.0ft	\$82.23
TAA00007-75F	Plenum Rated Shielded Category 6a Cable, RJ45 / RJ45, 23AWG Solid, White, 75.0ft	\$113.90
TAA00007-100F	Plenum Rated Shielded Category 6a Cable, RJ45 / RJ45, 23AWG Solid, White, 100.0ft	\$145.57
TAA00008-1F	Plenum Rated Shielded Category 6a Cable, RJ45 / RJ45, 23AWG Solid, Green, 1.0ft	\$20.17
TAA00008-2F	Plenum Rated Shielded Category 6a Cable, RJ45 / RJ45, 23AWG Solid, Green, 2.0ft	\$21.43
TAA00008-3F	Plenum Rated Shielded Category 6a Cable, RJ45 / RJ45, 23AWG Solid, Green, 3.0ft	\$22.70
TAA00008-5F	Plenum Rated Shielded Category 6a Cable, RJ45 / RJ45, 23AWG Solid, Green, 5.0ft	\$25.23
TAA00008-7F	Plenum Rated Shielded Category 6a Cable, RJ45 / RJ45, 23AWG Solid, Green, 7.0ft	\$27.77
TAA00008-10F	Plenum Rated Shielded Category 6a Cable, RJ45 / RJ45, 23AWG Solid, Green, 10.0ft	\$31.57
TAA00008-15F	Plenum Rated Shielded Category 6a Cable, RJ45 / RJ45, 23AWG Solid, Green, 15.0ft	\$37.90
TAA00008-20F	Plenum Rated Shielded Category 6a Cable, RJ45 / RJ45, 23AWG Solid, Green, 20.0ft	\$44.23
TAA00008-25F	Plenum Rated Shielded Category 6a Cable, RJ45 / RJ45, 23AWG Solid, Green, 25.0ft	\$50.57
TAA00008-30F	Plenum Rated Shielded Category 6a Cable, RJ45 / RJ45, 23AWG Solid, Green, 30.0ft	\$56.90
TAA00008-50F	Plenum Rated Shielded Category 6a Cable, RJ45 / RJ45, 23AWG Solid, Green, 50.0ft	\$82.23
TAA00008-75F	Plenum Rated Shielded Category 6a Cable, RJ45 / RJ45, 23AWG Solid, Green, 75.0ft	\$113.90
TAA00008-100F	Plenum Rated Shielded Category 6a Cable, RJ45 / RJ45, 23AWG Solid, Green, 100.0ft	\$145.57

M12 Connectors, Coupler and Receptacles

Item #	Description	1 Pc. Price
T5C00029	M12 4 Pin D-Code Shielded Panel Mountable Coupler	\$65.91
T5B00015	M12 4 Position D-Code Female Shielded Field Termination Connector	\$68.26
T5B00016	M12 4 Position D-Code Male Shielded Field Termination Connector	\$60.52
TAB00001	M12 8 Pin X-Code Male Shielded Field Termination Connector	\$80.06
TAC00003	M12 8 Pin X-Code Female Shielded Panel Mount Receptacle Front Mount Style	\$46.58
TAC00004	M12 8 Position X-Code Female Shielded Panel Mount Receptacle Rear Mount Style	\$46.58



TAA00006-F



TAA00007-F



TAA00008-F



T5C00029



T5B00015



T5B00016



TAB00001



TAC00003



TAC00004

Category 5e Adapters and Couplers

Item #	Description	1 Pc. Price
T5C00001	Category 5e RJ45 Coupler Unshielded (8x8) Panel Mount Style	\$11.15
T5C00002	Category 5e RJ45 Coupler Shielded (8x8) Panel Mount Style	\$13.86
T5C00003	Category 5e RJ45 Mini Coupler Unshielded RJ45 (8x8) Panel Mount Style	\$12.25
T5C00004	Category 5e RJ45 Mini Coupler Shielded RJ45 (8x8) Panel Mount Style	\$14.96
T5C00005	Ruggedized Flange Mount, Zinc-Nickel Finish with Grounding Shield	\$59.82
T5C00006	Ruggedized Flange Mount, Anodized Finish	\$45.02
T5C00007	Ruggedized Flange Mount, Zinc-Nickel Finish	\$51.79
T5C00008	Ruggedized Flange Mount, Zinc-Nickel Finish with Grounding Shield and Dust Cap	\$82.48
T5C00009	Ruggedized Flange Mount, Anodized Finish with Dust Cap	\$67.68
T5C00010	Ruggedized Flange Mount, Zinc-Nickel Finish with Dust Cap	\$75.65
T5C00011	Ruggedized Flange Mount, Zinc-Nickel Finish w/ Grounding Shield and Mounting Hardware	\$68.88
T5C00012	Ruggedized Flange Mount, Anodized Finish with Mounting Hardware	\$55.28
T5C00013	Ruggedized Flange Mount, Zinc-Nickel Finish with Mounting Hardware	\$62.06
T5C00014	Ruggedized Flange Mount, Zinc-Nickel Finish w/ Grounding Shield, Mounting Hardware and Dust Cap	\$93.84
T5C00015	Ruggedized Flange Mount, Anodized Finish with Mounting Hardware and Dust Cap	\$80.19
T5C00016	Ruggedized Flange Mount, Zinc-Nickel Finish w/ Mounting Hardware and Dust Cap	\$88.11
T5C00017	Ruggedized D38999 Jam-nut, Zinc-Nickel Finish	\$68.88
T5C00018	Ruggedized D38999 Jam-nut, Zinc-Nickel Finish w/ Grounding Shield and Dust Cap	\$129.42
T5C00019	Ruggedized Jam-nut, Anodized Finish	\$51.79
T5C00020	Ruggedized Jam-nut, Zinc-Nickel Finish	\$58.62
T5C00021	Category 5e, Ruggedized Jam-nut, Zinc-Nickel Finish	\$58.62
T5C00022	Ruggedized Jam-nut, Zinc-nickel Finish with Grounding Shield and Dust Cap	\$103.94
T5C00023	Ruggedized Jam-nut, Anodized Finish with Dust Cap	\$82.48
T5C00024	Category 5e, Ruggedized Jam-nut, Anodized Finish with Dust Cap	\$82.48
T5C00025	Ruggedized Jam-nut, Zinc-Nickel Finish with Dust Cap	\$92.64
T5C00026	Ruggedized Jam-nut, Zinc-Nickel Finish with Grounding Shield	\$68.88
T5C00027	Cat5e IP67 RJ45 Bulkhead Panel Mount Coupler, Shielded, Feed-Thru w/ Dust Cap	\$18.71
T5C00028	Cat5e IP67 RJ45 to 110 Bulkhead Panel Mount Coupler, Shielded, Feed-Thru, PoE+ w/ Dust Cap	\$19.65



Lanyards for Ruggedized Jam-Nuts/Flange Mounts

Item #	Description	1 Pc. Price
TMK00001	Dust Cap plus Collared Lanyard for Ruggedized Jam-Nuts, Zinc-Nickel Finish	\$35.49
TMK00003	Dust Cap plus Eyelet Lanyard for Ruggedized Flange Mounts, Zinc-Nickel Finish	\$25.74

Category 6 Couplers

Item #	Description	1 Pc. Price
T6C00001	Category 6 RJ45 Coupler Unshielded (8x8) Panel Mount Style	\$12.25
T6C00002	Category 6 RJ45 Coupler Shielded (8x8) Panel Mount Style	\$14.38
T6C00003	Category 6 RJ45 Mini Coupler Unshielded RJ45 (8x8) Panel Mount Style	\$13.34
T6C00004	Category 6 RJ45 Mini Coupler Shielded RJ45 (8x8) Panel Mount Style	\$15.48
T6C00005	Cat6 IP67 RJ45 Bulkhead Panel Mount Coupler, Shielded, Feed-Thru with Dust Cap	\$20.79
T6C00006	Cat6 IP67 RJ45 to 110 Bulkhead Panel Mount Coupler, Shielded, Feed-Thru, PoE+ w/ Dust Cap	\$20.79



Category 6a Couplers

Item #	Description	1 Pc. Price
TAC00001	Category 6a RJ45 Coupler Unshielded (8x8) Panel Mount Style	\$17.09
TAC00002	Category 6a RJ45 Coupler Shielded (8x8) Panel Mount Style	\$20.32



Category 3 Couplers

Item #	Description	1 Pc. Price
TMC00001	Category 3 RJ45 Coupler Unshielded (8x8) Panel Mount Style	\$8.45
TMC00002	Category 3 RJ45 Coupler Shielded (8x8) Panel Mount Style	\$11.15

USB | LSZH & Waterproof Cable Assemblies



MUS2A00017-M



MUS2A00018-M



MUS2A00001-M



MUS2A00002-M



MUS2A00003-M



MUS2A00004-M



MUS2A00005-M



MUS2A00012-M



MUS2A00013-M



MUS3A00058-M



MUS3A00061-M



MUS3A00057-M

USB 2.0 Latching LSZH Cable Assemblies

Item #	Description	1 Pc. Price
MUS2A00017-03M	LSZH USB Cable Assembly, Latching A / Latching A, 0.3m	\$19.96
MUS2A00017-05M	LSZH USB Cable Assembly, Latching A / Latching A, 0.5m	\$20.58
MUS2A00017-075M	LSZH USB Cable Assembly, Latching A / Latching A, 0.75m	\$21.47
MUS2A00017-1M	LSZH USB Cable Assembly, Latching A / Latching A, 1.0m	\$22.25
MUS2A00017-2M	LSZH USB Cable Assembly, Latching A / Latching A, 2.0m	\$25.38
MUS2A00017-3M	LSZH USB Cable Assembly, Latching A / Latching A, 3.0m	\$28.50
MUS2A00017-4M	LSZH USB Cable Assembly, Latching A / Latching A, 4.0m	\$31.53
MUS2A00017-5M	LSZH USB Cable Assembly, Latching A / Latching A, 5.0m	\$34.65
MUS2A00018-03M	LSZH USB Cable Assembly, Latching A / Standard B, 0.3m	\$18.14
MUS2A00018-05M	LSZH USB Cable Assembly, Latching A / Standard B, 0.5m	\$18.76
MUS2A00018-075M	LSZH USB Cable Assembly, Latching A / Standard B, 0.75m	\$19.65
MUS2A00018-1M	LSZH USB Cable Assembly, Latching A / Standard B, 1.0m	\$20.27
MUS2A00018-2M	LSZH USB Cable Assembly, Latching A / Standard B, 2.0m	\$23.40
MUS2A00018-3M	LSZH USB Cable Assembly, Latching A / Standard B, 3.0m	\$26.52
MUS2A00018-4M	LSZH USB Cable Assembly, Latching A / Standard B, 4.0m	\$29.70
MUS2A00018-5M	LSZH USB Cable Assembly, Latching A / Standard B, 5.0m	\$32.83

USB 2.0 Waterproof Cable Assemblies

Item #	Description	1 Pc. Price
MUS2A00001-2M	USB Cable, Waterproof Type A Male - Standard Type B Male	\$25.53
MUS2A00001-5M	USB Cable, Waterproof Type A Male - Standard Type B Male	\$30.01
MUS2A00002-2M	USB Cable, Waterproof Type B Male - Standard Type B Male	\$26.37
MUS2A00002-5M	USB Cable, Waterproof Type B Male - Standard Type B Male	\$30.01
MUS2A00003-05M	USB Cable, Waterproof Panel Mount Type A Female - Standard Type A Male	\$22.88
MUS2A00003-2M	USB Cable, Waterproof Panel Mount Type A Female - Standard Type A Male	\$25.33
MUS2A00003-3M	USB Cable, Waterproof Panel Mount Type A Female - Standard Type A Male	\$26.47
MUS2A00003-5M	USB Cable, Waterproof Panel Mount Type A Female - Standard Type A Male	\$28.82
MUS2A00004-05M	USB Cable, Waterproof Type B Female - Standard Type A Male	\$22.88
MUS2A00004-5M	USB Cable, Waterproof Type B Female - Standard Type A Male	\$28.82
MUS2A00005-2M	USB Cable, Waterproof Mini B 5 Female / Mini B 5 Male	\$27.62
MUS2A00012-05M	Shielded Waterproof Panel Mount Type A Female - Standard Type A Male	\$41.42
MUS2A00012-5M	Shielded Waterproof Panel Mount Type A Female - Standard Type A Male	\$48.09
MUS2A00013-05M	Shielded Waterproof Type A Male - Standard Type B Male	\$37.00
MUS2A00013-5M	Shielded Waterproof Type A Male - Standard Type B Male	\$42.26

See our website MilesTek.com for additional lengths.

USB 2.0 Waterproof Cable Assemblies

Item #	Description	1 Pc. Price
MUS3A00058-1M	Waterproof USB 2.0 Type C to Type A, 1.0m	\$30.80
MUS3A00058-3M	Waterproof USB 2.0 Type C to Type A, 3.0m	\$36.20

USB 3.0 Waterproof Cable Assemblies

Item #	Description	1 Pc. Price
MUS3A00061-1M	USB 3.0, Waterproof Type C Female to Type A Male, 1.0m	\$19.45

USB 3.0 Cable Assemblies

Item #	Description	1 Pc. Price
MUS3A00057-10M	USB 3.0 Type A to Micro B AOC w/ Locking Screws, 10.0m	\$805.00
MUS3A00057-20M	USB 3.0 Type A to Micro B AOC w/ Locking Screws, 20.0m	\$858.00

USB 3.0 Cable Assemblies

Item #	Description	1 Pc. Price
MUS3A00019-03M	USB 3.0 Cable, Type A / A with Thumbscrew Hardware	\$19.44
MUS3A00019-5M	USB 3.0 Cable, Type A / A with Thumbscrew Hardware	\$29.60
MUS3A00020-03M	USB 3.0 Cable, Type B / A with Thumbscrew Hardware	\$20.53
MUS3A00020-5M	USB 3.0 Cable, Type B / A with Thumbscrew Hardware	\$30.64
MUS3A00021-03M	USB 3.0 Cable, Type Micro B / A with Thumbscrew Hardware	\$21.57
MUS3A00021-5M	USB 3.0 Cable, Type Micro B / A with Thumbscrew Hardware	\$31.73
MUS3A00022-03M	USB 3.0 Cable, Type A / B with Thumbscrew Hardware	\$24.80
MUS3A00022-5M	USB 3.0 Cable, Type A / B with Thumbscrew Hardware	\$34.96
MUS3A00023-03M	USB 3.0 Cable, Type A / Micro B with Thumbscrew Hardware	\$25.90
MUS3A00023-5M	USB 3.0 Cable, Type A / Micro B with Thumbscrew Hardware	\$36.06
MUS3A00025-03M	USB 3.0 Machine Vision Panel Mount Cable Assembly	\$22.82
MUS3A00025-2M	USB 3.0 Machine Vision Panel Mount Cable Assembly	\$27.36

See our website MilesTek.com for additional lengths.

USB 3.1 Cable Assemblies

Item #	Description	1 Pc. Price
MUS3A00059-03M	USB 3.1 Type C Gen 2 Male/Male, 10 Gbps, 0.3m	\$21.85
MUS3A00059-05M	USB 3.1 Type C Gen 2 Male/Male, 10 Gbps, 0.5m	\$23.45
MUS3A00059-1M	USB 3.1 Type C Gen 2 Male/Male, 10 Gbps, 1.0m	\$24.60

USB 3.1 LSZH Cable Assemblies

Item #	Description	1 Pc. Price
MUS3A00060-03M	USB 3.1 LSZH Type C Gen 2 Male/Male, 10 Gbps, 0.3m	\$35.00
MUS3A00060-05M	USB 3.1 LSZH Type C Gen 2 Male/Male, 10 Gbps, 0.5m	\$36.00
MUS3A00060-1M	USB 3.1 LSZH Type C Gen 2 Male/Male, 10 Gbps, 1.0m	\$38.50

USB 3.0 Right Angle Cable Assemblies

Item #	Description	1 Pc. Price
MUS3A00062-05M	USB 3.0 Female to Male Type A Right Angle Up Exit, 0.5m	\$12.50
MUS3A00062-075M	USB 3.0 Female to Male Type A Right Angle Up Exit, 0.75m	\$12.75
MUS3A00062-1M	USB 3.0 Female to Male Type A Right Angle Up Exit, 1.0m	\$13.15
MUS3A00063-05M	USB 3.0 Female to Male Type A Right Angle, Right Exit, 0.5m	\$13.00
MUS3A00063-075M	USB 3.0 Female to Male Type A Right Angle, Right Exit, 0.75m	\$13.25
MUS3A00063-1M	USB 3.0 Female to Male Type A Right Angle, Right Exit, 1.0m	\$13.65
MUS3A00064-05M	USB 3.0 Female to Male Type A Right Angle, Left Exit, 0.5m	\$14.20
MUS3A00064-075M	USB 3.0 Female to Male Type A Right Angle, Left Exit, 0.75m	\$14.60
MUS3A00064-1M	USB 3.0 Female to Male Type A Right Angle, Left Exit, 1.0m	\$15.00

Jacks, Covers, Connectors and Hardware

Item #	Description	1 Pc. Price
MUS2A00006	Waterproof USB Type A Jack with 10" Wire Leads	\$20.84
MUS2A00007	Waterproof USB Type B Jack with 10" Wire Leads	\$20.84
MUS2B00008	Waterproof USB Cover	\$5.32
MUS2B00009	Waterproof Cap for USB + IEEE-1394 (Firewire)	\$8.45
MUS3B00001	Waterproof Type C Male to Type A Male, Panel Mounted PC Tail Connector	\$21.00
MUS2K00010	Nylon Nut for Housing Size 13/16-28	\$7.81
MUS2K00011	EPDM Rubber Gasket for Housing Size 13/16	\$4.04
MUS2B00014	Shielded Waterproof Cap for USB IP67 Cables	\$11.10
MUS2B00015	USB Type A Waterproof Field Installable Connector	\$17.20
MUS2B00016	USB Type B Waterproof Field Installable Connector	\$17.20





SZA00001-M



SZA00002-M



SZA00003-M



MGPA00003-M



MGPA00006-M



MGPA00007-M



MGPA00008-M



MGPA00009-M



MGPA00011-M



MGPB00001



MGPB00002



MGPB00003

LSZH SCSI-3 Cable Assemblies

Item #	Description	1 Pc. Price
SZA00001-1M	LSZH SCSI-3 Cable, HPDB68 Male / HPDB68 Male	\$124.99
SZA00001-3M	LSZH SCSI-3 Cable, HPDB68 Male / HPDB68 Male	\$168.08

See our website MilesTek.com for additional lengths.

Ultra SCSI Cable Assemblies

Item #	Description	1 Pc. Price
SZA00002-05M	Ultra SCSI Cable, .8mm Male / HPDB68 Male	\$85.03
SZA00002-3M	Ultra SCSI Cable, .8mm Male / HPDB68 Male	\$112.33
SZA00003-05M	Ultra SCSI Cable, .8mm Male / HPDB50 Male	\$85.03
SZA00003-3M	Ultra SCSI Cable, .8mm Male / HPDB50 Male	\$96.18
SZA00004-05M	Ultra SCSI Cable, .8mm Male / Male	\$93.51
SZA00004-3M	Ultra SCSI Cable, .8mm Male / Male	\$120.12

See our website MilesTek.com for additional lengths.

Premium IEEE-488 Cable Assemblies

Item #	Description	1 Pc. Price
MGPA00001-03M	Premium IEEE-488 Cable, Normal / Normal	\$119.00
MGPA00001-18M	Premium IEEE-488 Cable, Normal / Normal	\$398.99
MGPA00002-05M	Premium IEEE-488 Cable, Normal / Inline	\$114.10
MGPA00002-1M	Premium IEEE-488 Cable, Normal / Inline	\$119.89
MGPA00002-8M	Premium IEEE-488 Cable, Normal / Inline	\$201.63
MGPA00003-05M	Premium IEEE-488 Cable, Inline / Inline	\$108.22
MGPA00003-8M	Premium IEEE-488 Cable, Inline / Inline	\$195.85
MGPA00004-1M	Premium IEEE-488 Extension Cable	\$114.10
MGPA00004-3M	Premium IEEE-488 Extension Cable	\$137.44

See our website MilesTek.com for additional lengths.

Deluxe IEEE-488 Cable Assemblies

Item #	Description	1 Pc. Price
MGPA00005-03M	Deluxe IEEE-488 Cable	\$111.39
MGPA00005-8M	Deluxe IEEE-488 Cable	\$195.85

See our website MilesTek.com for additional lengths.

Molded IEEE-488 Cable Assemblies

Item #	Description	1 Pc. Price
MGPA00006-05M	Molded IEEE-488 Cable, Normal / Normal	\$79.77
MGPA00006-8M	Molded IEEE-488 Cable, Normal / Normal	\$148.44
MGPA00007-05M	Molded IEEE-488 Cable, Reverse / Reverse	\$83.26
MGPA00007-8M	Molded IEEE-488 Cable, Reverse / Reverse	\$155.16
MGPA00008-03M	Molded IEEE-488 Cable, Normal / Reverse	\$81.33
MGPA00008-1M	Molded IEEE-488 Cable, Normal / Reverse	\$88.05
MGPA00009-05M	Molded IEEE-488 Cable, Normal / Inline	\$69.30
MGPA00009-10M	Molded IEEE-488 Cable, Normal / Inline	\$149.79
MGPA00011-05M	Molded IEEE-488 Cable, Inline / Inline	\$49.03
MGPA00011-10M	Molded IEEE-488 Cable, Inline / Inline	\$146.87

See our website MilesTek.com for additional lengths.

IEEE-488 Connectors

Item #	Description	1 Pc. Price
MGPB00001	Female IEEE-488 Connector, Solder Lug Terminals	\$11.78
MGPB00002	Female IEEE-488 Connector, Straight PC Terminals	\$11.78
MGPB00003	Female IEEE-488 Connector, Right Angle PC Terminals	\$11.78

See our website, MilesTek.com to view all of our products.

LSZH 3.5mm Audio Cable Assemblies

Item #	Description	1 Pc. Price
MAVMA00001-3F	LSZH 3.5mm Audio Cable Assembly Male to Male-1/8", 3.0ft	\$5.70
MAVMA00001-5F	LSZH 3.5mm Audio Cable Assembly Male to Male-1/8", 5.0ft	\$7.15
MAVMA00001-10F	LSZH 3.5mm Audio Cable Assembly Male to Male-1/8", 10.0ft	\$10.50
MAVMA00001-15F	LSZH 3.5mm Audio Cable Assembly Male to Male-1/8", 15.0ft	\$13.85
MAVMA00001-25F	LSZH 3.5mm Audio Cable Assembly Male to Male-1/8", 25.0ft	\$20.45

DisplayPort Cable Assembly

Item #	Description	1 Pc. Price
MPDA00006-10I	Displayport Right Angle Male to Displayport Female Panel Mount 10 Inches	\$12.20

HDMI to DisplayPort LSZH Cable Assemblies

Item #	Description	1 Pc. Price
MMIA00006-05M	HDMI Male to DisplayPort Male LSZH, 0.5m	\$22.45
MMIA00006-1M	HDMI Male to DisplayPort Male LSZH, 1.0m	\$23.60
MMIA00006-2M	HDMI Male to DisplayPort Male LSZH, 2.0m	\$28.00
MMIA00006-3M	HDMI Male to DisplayPort Male LSZH, 3.0m	\$30.70
MMIA00006-5M	HDMI Male to DisplayPort Male LSZH, 5.0m	\$34.65

HDMI Bendable Adapters

Item #	Description	1 Pc. Price
MMIC00003	HDMI Bendable and Swivel Adapter Female to Female	\$10.75
MMIC00004	HDMI Bendable Adapter Male to Female	\$10.75
MMIC00005	HDMI Bendable Adapter Male to Male	\$10.75
MMIC00006	HDMI Bendable Adapter Male to Female	\$10.75

12G SDI Connectors

Item #	Description	1 Pc. Price
MAVB00001	Ultra Tiny BNC Plug for 1855A	\$6.20
MAVB00002	Ultra Tiny BNC Jack, End Launch	\$5.50
MAVB00003	Ultra Tiny BNC Jack, PCB Type	\$5.80
MAVB00004	Ultra Tiny BNC R/A BH Jack	\$6.70
MAVB00005	Ultra Tiny BNC Crimp Jack for Belden 1855A	\$5.65
MAVB00006	Ultra Tiny BNC Crimp Jack for Belden 1855A	\$6.15
MAVB00007	BNC Crimp Plug for 1855ENH	\$3.80
MAVB00008	BNC B/H End Launch Jack 1.6t	\$6.40
MAVB00009	BNC Bulkhead Jack RearMount	\$8.65
MAVB00010	BNC ST Jack, PCB Type	\$5.90
MAVB00011	BNC ST Jack for Belden 1855A	\$4.95
MAVB00012	BNC B/H Jack for Belden 1855A	\$6.25
MAVB00013	BNC Straight Jack PCB Type 4 leg	\$4.00
MAVB00014	BNC R/A Bulkhead Jack PCB Type	\$13.25
MAVB00015	Ultra Tiny BNC BH Jack to Jack	\$8.30
MAVB00016	BNC (M) to Ultra Tiny BNC (F)	\$6.50
MAVB00017	BNC Jack Ultra Tiny BNC Plug	\$8.30





MDA00022-F

MDA00023-F

MDA00024-F

MDA00025-F

MDA00026-F

MDA00027-F

MDA00028-F

MDA00029-F

MDA00030-F

MDA00031-F

MDA00032-F

MDA00033-F

MDA00034-F

MDA00035-F

MDA00036-F

MDA00037-F

MDA00038-F

MDA00039-F

MDA00040-F

MDA00041-F

MDA00042-F

MDA00043-F

MDA00044-F

MDA00045-F

MDA00046-F

MDA00047-F

MDA00048-F

MDA00049-F

MDA00050-F

MDA00051-F

MDA00052-F

MDA00053-F

MDA00054-F

MDA00055-F

MDA00056-F

MDA00057-F

MDA00058-F

MDA00059-F

MDA00060-F

MDA00061-F

MDA00062-F

MDA00063-F

MDA00064-F

MDA00065-F

MDA00066-F

DVI-D Single & Dual Link Angled Cable Assemblies

Item #	Description	1 Pc. Price
MDA00022-1F	DVI-D Single Link DVI Cable Male / Male Right Angle, Bottom	\$23.35
MDA00022-3F	DVI-D Single Link DVI Cable Male / Male Right Angle, Bottom	\$25.27
MDA00023-05M	DVI-D Single Link DVI Cable Male / Male Right Angle, Bottom	\$18.76
MDA00023-1M	DVI-D Single Link DVI Cable Male / Male Right Angle, Bottom	\$25.53
MDA00024-1F	DVI-D Single Link DVI Cable Male / Male Right Angle, Top	\$23.35
MDA00024-3F	DVI-D Single Link DVI Cable Male / Male Right Angle, Top	\$25.27
MDA00025-05M	DVI-D Single Link DVI Cable Male / Male Right Angle	\$18.76
MDA00025-1M	DVI-D Single Link DVI Cable Male / Male Right Angle	\$25.53
MDA00026-1F	DVI-D Single Link DVI Cable Male / Male Right Angle, Left	\$23.35
MDA00026-3F	DVI-D Single Link DVI Cable Male / Male Right Angle, Left	\$25.27
MDA00027-1F	DVI-D Single Link DVI Cable Male / Male Right Angle, Right	\$23.35
MDA00027-3F	DVI-D Single Link DVI Cable Male / Male Right Angle, Right	\$25.27
MDA00028-1F	DVI-D Dual Link DVI Cable Male / Male Right Angle, Bottom	\$28.24
MDA00028-3F	DVI-D Dual Link DVI Cable Male / Male Right Angle, Bottom	\$31.21
MDA00029-05M	DVI-D Dual Link DVI Cable Male / Male Right Angle, Bottom	\$29.29
MDA00029-1M	DVI-D Dual Link DVI Cable Male / Male Right Angle, Bottom	\$31.47
MDA00030-1F	DVI-D Dual Link DVI Cable Male / Male Right Angle, Top	\$28.24
MDA00030-3F	DVI-D Dual Link DVI Cable Male / Male Right Angle, Top	\$31.21
MDA00031-05M	DVI-D Dual Link DVI Cable Male / Male Right Angle, Top	\$29.29
MDA00031-1M	DVI-D Dual Link DVI Cable Male / Male Right Angle, Top	\$31.47
MDA00032-1F	DVI-D Dual Link DVI Cable Male / Male Right Angle, Left	\$28.24
MDA00032-3F	DVI-D Dual Link DVI Cable Male / Male Right Angle, Left	\$31.21
MDA00033-1F	DVI-D Dual Link DVI Cable Male / Male Right Angle, Right	\$28.24
MDA00033-3F	DVI-D Dual Link DVI Cable Male / Male Right Angle, Right	\$41.63

See our website MilesTek.com for additional lengths.

DVI-D Single & Dual Link LSZH Angled Cable Assemblies

Item #	Description	1 Pc. Price
MDA00039-1F	DVI-D Single Link LSZH DVI Cable Male / Male Right Angle, Bottom	\$26.32
MDA00039-15F	DVI-D Single Link LSZH DVI Cable Male / Male Right Angle, Bottom	\$41.48
MDA00040-1F	DVI-D Single Link LSZH DVI Cable Male / Male Right Angle, Top	\$26.32
MDA00040-15F	DVI-D Single Link LSZH DVI Cable Male / Male Right Angle, Top	\$41.48
MDA00041-1F	DVI-D Single Link LSZH DVI Cable Male / Male Right Angle, Left	\$26.32
MDA00041-15F	DVI-D Single Link LSZH DVI Cable Male / Male Right Angle, Left	\$41.48
MDA00042-1F	DVI-D Single Link LSZH DVI Cable Male / Male Right Angle, Right	\$26.32
MDA00042-15F	DVI-D Single Link LSZH DVI Cable Male / Male Right Angle, Right	\$41.48
MDA00043-1F	DVI-D Dual Link LSZH DVI Cable Male / Male Right Angle, Bottom	\$31.73
MDA00043-15F	DVI-D Dual Link LSZH DVI Cable Male / Male Right Angle, Bottom	\$58.20
MDA00044-1F	DVI-D Dual Link LSZH DVI Cable Male / Male Right Angle, Top	\$31.73
MDA00044-15F	DVI-D Dual Link LSZH DVI Cable Male / Male Right Angle, Top	\$58.20
MDA00045-1F	DVI-D Dual Link LSZH DVI Cable Male / Male Right Angle, Left	\$31.73
MDA00045-15F	DVI-D Dual Link LSZH DVI Cable Male / Male Right Angle, Left	\$58.20
MDA00046-1F	DVI-D Dual Link LSZH DVI Cable Male / Male Right Angle, Right	\$31.73
MDA00046-15F	DVI-D Dual Link LSZH DVI Cable Male / Male Right Angle, Right	\$58.20

See our website MilesTek.com for additional lengths.

Premium DVI to HDMI Cable Assembly

Item #	Description	1 Pc. Price
MPDA00001-05M	Premium DVI to HDMI Cable Assembly, HDMI-Male / DVI-D Single Link-Male	\$23.61

Assembly prices shown for shortest length in the series. See our website for additional lengths.

DisplayPort LSZH Cable Assembly & Panel Mount Adapter

Item #	Description	1 Pc. Price
MPDA00001-05M	LSZH DisplayPort Cable Male-Male	\$30.64
MDC00010	DisplayPort Panel Mount Adapter Female DP / Female DP	\$19.33

Assembly prices shown for shortest length in the series. See our website for additional lengths.

Premium DVI-D Cable Assemblies with Ferrites

Item #	Description	1 Pc. Price
MDA00011-3F	Premium DVI-D Single Link DVI Cable Male / Male with Ferrites	\$25.74
MDA00011-5F	Premium DVI-D Single Link DVI Cable Male / Male with Ferrites	\$27.93
MDA00012-1F	Deluxe DVI-D Single Link DVI Cable Male / Male with Ferrites	\$14.96
MDA00012-3F	Deluxe DVI-D Single Link DVI Cable Male / Male with Ferrites	\$17.09
MDA00013-3F	Premium DVI-D Dual Link DVI Cable Male / Male with Ferrites	\$34.39
MDA00013-5F	Premium DVI-D Dual Link DVI Cable Male / Male with Ferrites	\$36.53
MDA00014-1F	Deluxe DVI-D Dual Link DVI Cable, Male / Male with Ferrites	\$20.32
MDA00014-3F	Deluxe DVI-D Dual Link DVI Cable, Male / Male with Ferrites	\$22.51
MDA00015-3F	DVI-D Single Link LSZH Cable Male / Male with Ferrites	\$20.32
MDA00015-5F	DVI-D Single Link LSZH Cable Male / Male with Ferrites	\$22.51
MDA00016-3F	DVI-D Dual Link LSZH Cable Male / Male with Ferrites	\$27.93
MDA00016-5F	DVI-D Dual Link LSZH Cable Male / Male with Ferrites	\$32.20
MDA00017-3F	Premium DVI-I Single Link DVI Cable Male / Male with Ferrites	\$37.62
MDA00017-5F	Premium DVI-I Single Link DVI Cable Male / Male with Ferrites	\$40.85
MDA00018-3F	Premium DVI-I Dual Link DVI Cable Male / Male with Ferrites	\$39.76
MDA00018-5F	Premium DVI-I Dual Link DVI Cable Male / Male with Ferrites	\$43.04
MDA00019-1F	Deluxe DVI-I Dual Link DVI Cable Male / Male with Ferrites	\$21.94
MDA00019-3F	Deluxe DVI-I Dual Link DVI Cable Male / Male with Ferrites	\$23.03
MDA00020-3F	Premium DVI-A Male DVI Cable / HD15 Male with Ferrites	\$24.65
MDA00020-5F	Premium DVI-A Male DVI Cable / HD15 Male with Ferrites	\$27.93

See our website MilesTek.com for additional lengths.

DVI-D 45 Degree Cable Assemblies

Item #	Description	1 Pc. Price
MDA00034-1F	DVI-D Single Link DVI Cable Male / Male 45 Degree Left	\$23.35
MDA00034-15F	DVI-D Single Link DVI Cable Male / Male 45 Degree Left	\$35.54
MDA00035-1M	DVI-D Single Link DVI Cable Male / Male 45 Degree Left	\$25.53
MDA00035-5M	DVI-D Single Link DVI Cable Male / Male 45 Degree Left	\$37.15
MDA00036-1F	DVI-D Dual Link DVI Cable Male / Male 45 Degree Left	\$28.24
MDA00036-15F	DVI-D Dual Link DVI Cable Male / Male 45 Degree Left	\$49.29
MDA00037-1F	DVI-D Single Link LSZH DVI Cable Male / Male 45 Degree Left	\$25.53
MDA00037-15F	DVI-D Single Link LSZH DVI Cable Male / Male 45 Degree Left	\$51.69
MDA00037-2M	DVI-D Single Link LSZH DVI Cable Male / Male 45 Degree Left	\$37.15
MDA00037-5M	DVI-D Single Link LSZH DVI Cable Male / Male 45 Degree Left	\$52.78
MDA00038-5F	DVI-D Dual Link LSZH DVI Cable Male / Male 45 Degree Left	\$39.55
MDA00038-15F	DVI-D Dual Link LSZH DVI Cable Male / Male 45 Degree Left	\$65.49

See our website MilesTek.com for additional lengths.

DVI Panel Mount Cable Assemblies

Item #	Description	1 Pc. Price
MDA00047-1F	Premium Panel Mount DVI-D Single Link Male / Female Cable Assembly	\$23.92
MDA00048-1F	Premium Panel Mount DVI-D Dual Link Male / Female Cable Assembly	\$32.25
MMIA00001-05M	High Speed HDMI Cable with Ethernet, Male / Panel Mount Female	\$24.60

Assembly prices shown for shortest length in the series. See our website for additional lengths.

Audio/Video Adapters

Item #	Description	1 Pc. Price
MDC00001	DVI Adapter, DVI-A Male / HD15 Female	\$13.19
MDC00002	DVI Adapter, DVI-A Female / HD15 Male	\$13.92
MDC00004	DVI Adapter, DVI-I Female / HDMI Male	\$13.45
MDC00005	DVI Adapter, DVI-I Female / HDMI Female	\$13.45
MDC00006	DVI Adapter, DVI-D Male / HDMI Male	\$13.45
MDC00008	DVI Bulkhead Adapter Female / Female	\$19.54
MDC00009	HDMI Panel Mount Adapter, Female / Female	\$15.22

See our website MilesTek.com for all of our Audio/Video adapters.

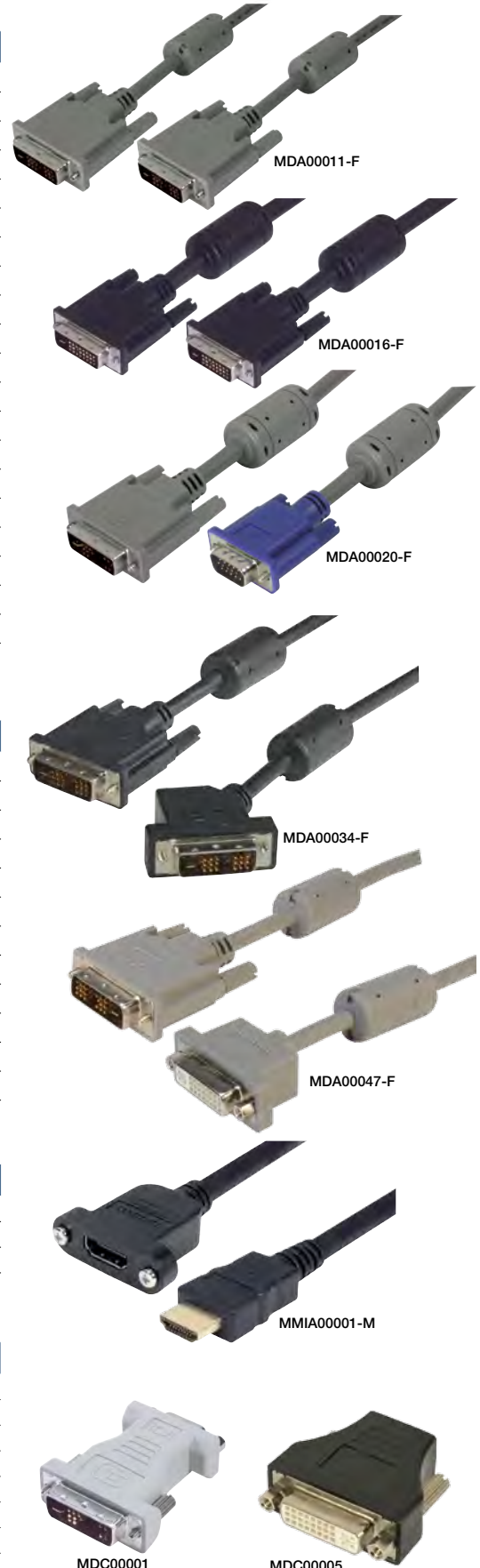



F1A00001-M
F2A00001-M
F3A00001-M



F1A00002-M
F2A00002-M
F3A00002-M



F1A00003-M
F2A00003-M
F3A00003-M



F1A00004-M
F2A00004-M
F3A00004-M



FSA00002-M



FSA00003-M



FSA00004-M

F1A - OM1 Assemblies

Item #	Description	1 Pc. Price
F1A00001-1M	OM1 IP67 Fiber Cable, Dual LC / Dual LC	\$191.13
F1A00002-1M	OM1 62.5/125, Military Fiber Cable, Dual LC / Dual LC	\$54.20
F1A00003-1M	OM1 62.5/125, Military Fiber Cable, Dual SC / Dual SC	\$45.06
F1A00004-1M	OM1 62.5/125, Military Fiber Cable, Dual ST / Dual ST	\$91.56

Assembly prices shown for 1.0m length. Also available 3.0m, 5.0m and 10.0m lengths.

F2A - OM2 Assemblies

Item #	Description	1 Pc. Price
F2A00001-1M	OM2 50/125, IP67 Multimode Fiber Cable, Dual LC / Dual LC	\$209.27
F2A00002-1M	OM2 50/125, Military Fiber Cable, Dual LC / Dual LC	\$56.53
F2A00003-1M	OM2 50/125, Military Fiber Cable, Dual SC / Dual SC	\$45.07
F2A00004-1M	OM2 50/125, Military Fiber Cable, Dual ST / Dual ST	\$90.03

Assembly prices shown for 1.0m length. Also available 3.0m, 5.0m and 10.0m lengths.

F3A - OM3 Assemblies

Item #	Description	1 Pc. Price
F3A00001-1M	OM3 50/125, 10 Gig, IP67 Multimode Fiber Cable, Dual LC / Dual LC	\$214.67
F3A00002-1M	OM3 50/125 10 Gig, Military Fiber Cable, Dual LC / Dual LC	\$61.48
F3A00003-1M	OM2 50/125, 10 Gig, Military Fiber Cable, Dual SC / Dual SC	\$50.33
F3A00004-1M	OM3 50/125 10 Gig, Military Fiber Cable, Dual ST / Dual ST	\$95.04

Assembly prices shown for 1.0m length. Also available 3.0m, 5.0m and 10.0m lengths.

FSA - Single mode Assemblies

Item #	Description	1 Pc. Price
FSA00001-1M	Single mode IP67 Fiber Cable, Dual LC / Dual LC	\$202.47
FSA00002-1M	9/125 Single mode, Military Fiber Cable, Dual LC / Dual LC	\$61.48
FSA00003-1M	9/125 Single mode, Military Fiber Cable, Dual SC / Dual SC	\$46.58
FSA00004-1M	9/125 Single mode, Military Fiber Cable, Dual ST / Dual ST	\$185.65

Assembly prices shown for 1.0m length. Also available 3.0m, 5.0m and 10.0m lengths.

Custom connectorization and configuration options available.

FYB - Connectors

Item #	Description	1 Pc. Price
FYB00001	MIL M83522 ST Connector, Multimode Locking Nickel Plated Brass for 2mm Fiber	\$34.86
FYB00002	MIL M83522 ST Connector, Single mode Locking Nickel Plated Brass for 2mm Fiber	\$36.63
FYB00003	MIL M83522 ST Connector, Multimode Non-Locking Nickel Plated Brass for 2mm Fiber	\$18.34
FYB00004	MIL M83522 ST Connector, Multimode Non-Locking Stainless Steel for 2mm Fiber	\$26.32
FYB00005	MIL M83522 ST Connector, Multimode Non-Locking Stainless Steel for 2mm Fiber	\$18.40
FYB00006	MIL M83522 ST Connector, Single mode Non-Locking Stainless Steel for 2mm Fiber	\$26.42
FYB00007	Duplex Multimode LC IP67 Connector	\$76.26
FYB00008	Duplex Single mode LC IP67 Connector	\$94.88
FYB00009	Ruggedized LC IP68 Plug, Duplex, Multimode with Dust Cap	\$148.97
FYB00010	Ruggedized LC IP68 Plug, Duplex, Single mode with Dust Cap	\$148.45
FYB00011	Ruggedized LC IP68 Plug, Duplex, Single mode APC Polish with Dust Cap	\$155.20
FYB00012	Ruggedized LC IP68 In-Line Receptacle, Duplex, Multimode with Dust Cap	\$185.86
FYB00013	Ruggedized LC IP68 In-Line Receptacle, Duplex, Single mode with Dust Cap	\$190.80
FYB00014	Rugged LC IP68 In-Line Receptacle, Duplex, Single mode APC Polish with Dust Cap	\$206.32



FYC - Adapters

Item #	Description	1 Pc. Price
FYC00001	MIL M83522 ST Coupler, Multimode & Single mode Nickel Plated Brass	\$20.32
FYC00002	MIL M83522 ST Coupler, Multimode & Single mode Stainless Steel	\$40.33
FYC00004	MIL M83522 ST Coupler, Multimode & Single mode Stainless Steel	\$41.06
FYC00005	Multimode IP67 Duplex LC Bulkhead Adapter	\$53.64
FYC00006	Single mode IP67 Duplex LC Bulkhead Adapter	\$64.54
FYC00009	Ruggedized LC IP68 Flange Mount Receptacle, Duplex, Multimode w/ Dust Cap	\$75.07
FYC00010	Ruggedized LC IP68 Flange Mount Receptacle, Duplex, Single Mode w/ Dust Cap	\$74.42
FYC00011	Ruggedized LC IP68 Flange Mount Receptacle, Duplex, Single Mode APC Polish w/ Dust Cap	\$76.13
FYC00012	Ruggedized LC IP68 Jam Nut Receptacle, Duplex, Multimode w/ Dust Cap	\$85.41
FYC00013	Ruggedized LC IP68 Jam Nut Receptacle, Duplex, Single Mode w/ Dust Cap	\$74.99
FYC00014	Rugged LC IP68 Jam Nut Receptacle, Duplex, Single Mode APC Polish w/ Dust Cap	\$85.41
FYC00015	Ruggedized LC IP68 D38999 Jam Nut Receptacle, Duplex, Multimode w/ Dust Cap	\$96.41
FYC00016	Rugged LC IP68 D38999 Jam Nut Receptacle, Duplex, Single Mode w/ Dust Cap	\$96.41
FYC00017	Ruggedized LC IP68 D38999 Jam Nut Receptacle, Duplex, Single Mode APC Polish w/ Dust Cap	\$96.41
FYC00018	Ruggedized LC IP68 Daisy Chain Receptacle, Duplex, Multimode w/ Dust Cap	\$68.30
FYC00019	Ruggedized LC IP68 Daisy Chain Receptacle, Duplex, Single Mode w/ Dust Cap	\$68.13
FYC00020	Ruggedized LC IP68 Daisy Chain Receptacle, Duplex, Single Mode APC Polish w/ Dust Cap	\$68.46



FYK - Hardware

Item #	Description	1 Pc. Price
FYK00001	IP67 Duplex LC Cap with Chain for Bulkhead Receptacle	\$15.96
FYK00004	IP67 Duplex LC Cap with Chain for Industrial Plugs	\$21.29
FYK00005	ST Dust Cap for MIL & Ruggedized COTS Couplers, Nickel Plated Brass w/ Lanyard	\$23.71
FYK00006	ST Dust Cap for MIL & Ruggedized COTS Couplers, Stainless Steel with Lanyard	\$26.47
FYK00007	ST Dust Cap for MIL & Rugged COTS Connectors, Nickel Plated Brass with Lanyard	\$27.51
FYK00008	ST Dust Cap for MIL & Ruggedized COTS Connectors, Stainless Steel with Lanyard	\$30.38
FYK00009	MIL M83522 ST Crimp Ferrule for use with 2.5 & 3mm Fiber	\$5.74



See our website to view all of our products.

Universal Sub-Panels

MilesTek's versatile Sub-Panel selection includes a multitude of connector configurations to satisfy all your connectivity needs. We offer Fiber Optic, GPIB, RJ45 Patch Panel, RJ11, RJ12 modular, D-subminiature, USB, Audio/Video, and Mini Din Sub-Panels. Each Sub-Panel can be mounted in the 6 bay, 19" REF00001 Master Rack Panel.

Item #	Description	1 Pc. Price
REF00001	3.5" X 19" Universal Master Rack Panel	\$31.77
REF00046	Universal Rack Panel Kit, Black Color with 6 Black Steel Sub-Panels	\$59.12
REF00140	Universal Rack Panel Kit, with 6 Black Aluminum Sub-Panels	\$59.04
REF00047	Universal Plastic Blank Sub-Panel, White	\$5.75
REF00002	Universal Sub-Panel, Steel	\$5.75
REF00048	Universal Aluminum Blank Sub-Panel, Black	\$5.75
REF00045	1.75" Cable Management Bracket Kit for 19" Panels	\$55.64
REF00148	1 Jack Panel Insert Bulkhead Rear Mount TRB 4 Lug Non Isolated	\$44.27
REF00149	1 Jack Panel Insert Bulkhead Rear Mount TRB 2 Lug Non Isolated	\$44.27
REF00150	1 Jack Panel Insert Bulkhead Rear Mount TRT Threaded Non Isolated	\$44.27
REF00151	1 Jack Panel Insert Bulkhead Feed Through TRB 3 Lug Non Isolated	\$46.04
REF00152	1 Jack Panel Insert Bulkhead Feed Through TRB 2 Lug Non Isolated	\$49.48
REF00153	1 Jack Panel Insert Bulkhead Feed Through TRT Threaded Non Isolated	\$49.48
REF00154	2 Jack Panel Insert Bulkhead Rear Mount TRB 3 Lug Non Isolated	\$64.07
REF00155	2 Jack Panel Insert Bulkhead Rear Mount TRB 4 Lug Non Isolated	\$79.70
REF00156	2 Jack Panel Insert Bulkhead Rear Mount TRB 2 Lug Non Isolated	\$79.70
REF00157	2 Jack Panel Insert Bulkhead Rear Mount TRT Threaded Non Isolated	\$79.70
REF00158	2 Jack Panel Insert Bulkhead Feed Through TRB 3 Lug Non Isolated	\$83.24
REF00159	2 Jack Panel Insert Bulkhead Feed Through TRB 2 Lug Non Isolated	\$90.12
REF00160	2 Jack Panel Insert Bulkhead Feed Through TRT Threaded Non Isolated	\$90.12
REF00161	3 Jack Panel Insert Bulkhead Rear Mount TRB 3 Lug Non Isolated	\$92.72
REF00162	3 Jack Panel Insert Bulkhead Rear Mount TRB 4 Lug Non Isolated	\$116.17
REF00163	3 Jack Panel Insert Bulkhead Rear Mount TRB 2 Lug Non Isolated	\$116.17
REF00164	3 Jack Panel Insert Bulkhead Rear Mount TRT Threaded Non Isolated	\$116.17
REF00165	3 Jack Panel Insert Bulkhead Feed Through TRB 3 Lug Non Isolated	\$121.48
REF00166	3 Jack Panel Insert Bulkhead Feed Through TRB 2 Lug Non Isolated	\$131.80
REF00167	3 Jack Panel Insert Bulkhead Feed Through TRT Threaded Non Isolated	\$131.80
REF00168	4 Jack Panel Insert Bulkhead Rear Mount TRB 3 Lug Non Isolated	\$121.38
REF00169	4 Jack Panel Insert Bulkhead Rear Mount TRB 4 Lug Non Isolated	\$152.64
REF00170	4 Jack Panel Insert Bulkhead Rear Mount TRB 2 Lug Non Isolated	\$152.64
REF00171	4 Jack Panel Insert Bulkhead Rear Mount TRT Threaded Non Isolated	\$152.64
REF00172	4 Jack Panel Insert Bulkhead Feed Through TRB 3 Lug Non Isolated	\$159.72
REF00173	4 Jack Panel Insert Bulkhead Feed Through TRB 2 Lug Non Isolated	\$173.48
REF00174	4 Jack Panel Insert Bulkhead Feed Through TRT Threaded Non Isolated	\$173.48

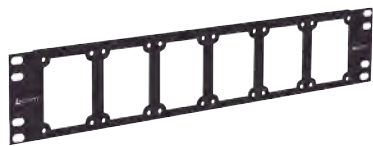

REF00001



REF00140



REF00147



REF00155



REF00157



REF00160



REF00161



REF00165



REF00167



REF00169



REF00170



REF00172

Universal Sub-Panels

Item #	Description	1 Pc. Price
REF00175-12N	1 Jack Panel Insert Bulkhead Rear Mount TRB 3 Lug Non Isolated Jack with 30-02001 Lead 12"	\$48.21
REF00176-12N	1 Jack Panel Insert Bulkhead Rear Mount TRB 3 Lug Non Isolated Jack with 30-02003 Lead 12"	\$48.16
REF00177-12N	1 Jack Panel Insert Bulkhead Rear Mount TRB 3 Lug Non Isolated Jack with M17/176-00002 Lead 12"	\$50.35
REF00178-12N	1 Jack Panel Insert Bulkhead Rear Mount TRB 3 Lug Non Isolated Jack with 30-02002 Lead 12"	\$49.79
REF00179-12N	1 Jack Panel Insert Bulkhead Rear Mount TRB 3 Lug Non Isolated Bend Relief Spring Jack with 30-02001 Lead 12"	\$98.56
REF00180-12N	1 Jack Panel Insert Bulkhead Rear Mount TRB 3 Lug Non Isolated Bend Relief Spring Jack with 30-02003 Lead 12"	\$98.51
REF00181-12N	1 Jack Panel Insert Bulkhead Rear Mount TRB 3 Lug Non Isolated Bend Relief Spring Jack with M17/176-00002 Lead 12"	\$105.58
REF00182-12N	1 Jack Panel Insert Bulkhead Rear Mount TRB 3 Lug Non Isolated Bend Relief Spring Jack with 30-02002 Lead 12"	\$101.89
REF00183-12N	2 Jack Panel Insert Bulkhead Rear Mount TRB 3 Lug Non Isolated Jack with 30-02001 Lead 12"	\$89.66
REF00184-12N	2 Jack Panel Insert Bulkhead Rear Mount TRB 3 Lug Non Isolated Jack with 30-02003 Lead 12"	\$89.55
REF00185-12N	2 Jack Panel Insert Bulkhead Rear Mount TRB 3 Lug Non Isolated Jack with M17/176-00002 Lead 12"	\$93.95
REF00186-12N	2 Jack Panel Insert Bulkhead Rear Mount TRB 3 Lug Non Isolated Jack with 30-02002 Lead 12"	\$92.83
REF00187-12N	2 Jack Panel Insert Bulkhead Rear Mount TRB 3 Lug Non Isolated Bend Relief Spring Jack with 30-02001 Lead 12"	\$190.36
REF00188-12N	2 Jack Panel Insert Bulkhead Rear Mount TRB 3 Lug Non Isolated Bend Relief Spring Jack with 30-02003 Lead 12"	\$190.25
REF00189-12N	2 Jack Panel Insert Bulkhead Rear Mount TRB 3 Lug Non Isolated Bend Relief Spring Jack with M17/176-00002 Lead 12"	\$204.40
REF00190-12N	2 Jack Panel Insert Bulkhead Rear Mount TRB 3 Lug Non Isolated Bend Relief Spring Jack with 30-02002 Lead 12"	\$197.03
REF00191-12N	3 Jack Panel Insert Bulkhead Rear Mount TRB 3 Lug Non Isolated Jack with 30-02001 Lead 12"	\$131.11
REF00192-12N	3 Jack Panel Insert Bulkhead Rear Mount TRB 3 Lug Non Isolated Jack with 30-02003 Lead 12"	\$130.95
REF00193-12N	3 Jack Panel Insert Bulkhead Rear Mount TRB 3 Lug Non Isolated Jack with M17/176-00002 Lead 12"	\$137.55
REF00194-12N	3 Jack Panel Insert Bulkhead Rear Mount TRB 3 Lug Non Isolated Jack with 30-02002 Lead 12"	\$135.86
REF00195-12N	3 Jack Panel Insert Bulkhead Rear Mount TRB 3 Lug Non Isolated Bend Relief Spring Jack with 30-02001 Lead 12"	\$281.43
REF00196-12N	3 Jack Panel Insert Bulkhead Rear Mount TRB 3 Lug Non Isolated Bend Relief Spring Jack with 30-02003 Lead 12"	\$282.00
REF00197-12N	3 Jack Panel Insert Bulkhead Rear Mount TRB 3 Lug Non Isolated Bend Relief Spring Jack with M17/176-00002 Lead 12"	\$303.23

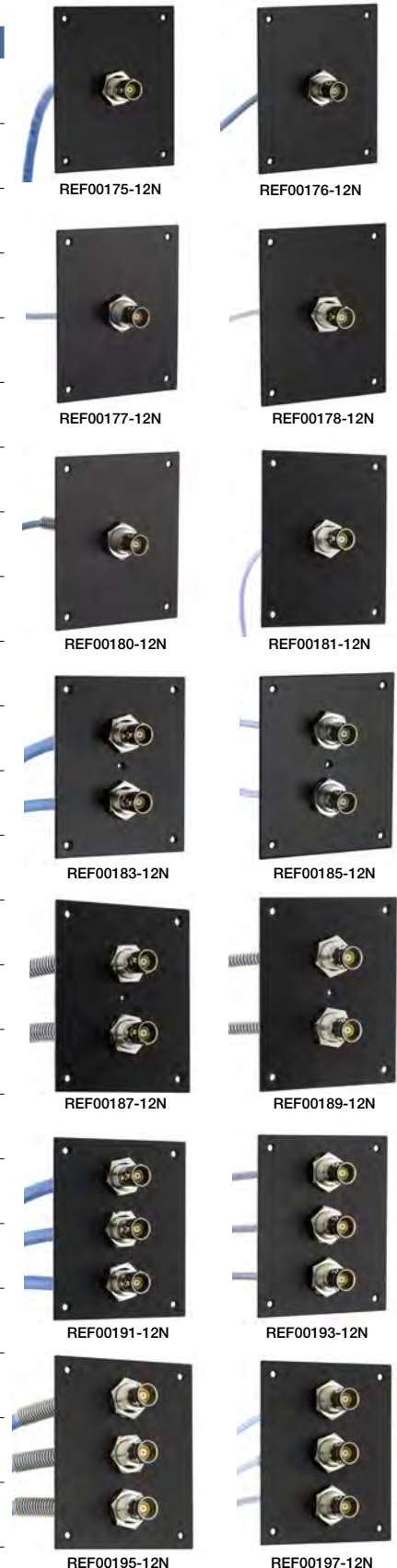

Universal Sub-Panels



Item #	Description	1 Pc. Price
REF00219-12N	1 Jack Panel Insert Bulkhead Rear Mount TRB 3 Lug Isolated Jack with 30-02001 Lead 12"	\$54.62
REF00220-12N	1 Jack Panel Insert Bulkhead Rear Mount TRB 3 Lug Isolated Jack with 30-02003 Lead 12"	\$54.57
REF00221-12N	1 Jack Panel Insert Bulkhead Rear Mount TRB 3 Lug Isolated Jack with M17/176-00002 Lead 12"	\$56.77
REF00222-12N	1 Jack Panel Insert Bulkhead Rear Mount TRB 3 Lug Isolated Jack with 30-02002 Lead 12"	\$57.96
REF00223-12N	1 Jack Panel Insert Bulkhead Rear Mount TRB 3 Lug Isolated Bend Relief Spring Jack with 30-02001 Lead 12"	\$69.06
REF00224-12N	1 Jack Panel Insert Bulkhead Rear Mount TRB 3 Lug Isolated Bend Relief Spring Jack with 30-02003 Lead 12"	\$69.01
REF00225-12N	1 Jack Panel Insert Bulkhead Rear Mount TRB 3 Lug Isolated Bend Relief Spring Jack with M17/176-00002 Lead 12"	\$71.21
REF00226-12N	1 Jack Panel Insert Bulkhead Rear Mount TRB 3 Lug Isolated Bend Relief Spring Jack with 30-02002 Lead 12"	\$72.40
REF00227-12N	2 Jack Panel Insert Bulkhead Rear Mount TRB 3 Lug Isolated Jack with 30-02001 Lead 12"	\$97.26
REF00228-12N	2 Jack Panel Insert Bulkhead Rear Mount TRB 3 Lug Isolated Jack with 30-02003 Lead 12"	\$97.16
REF00229-12N	2 Jack Panel Insert Bulkhead Rear Mount TRB 3 Lug Isolated Jack with M17/176-00002 Lead 12"	\$101.56
REF00230-12N	2 Jack Panel Insert Bulkhead Rear Mount TRB 3 Lug Isolated Jack with 30-02002 Lead 12"	\$103.94
REF00231-12N	2 Jack Panel Insert Bulkhead Rear Mount TRB 3 Lug Isolated Bend Relief Spring Jack with 30-02001 Lead 12"	\$126.14
REF00232-12N	2 Jack Panel Insert Bulkhead Rear Mount TRB 3 Lug Isolated Bend Relief Spring Jack with 30-02003 Lead 12"	\$126.04
REF00233-12N	2 Jack Panel Insert Bulkhead Rear Mount TRB 3 Lug Isolated Bend Relief Spring Jack with M17/176-00002 Lead 12"	\$130.44
REF00234-12N	2 Jack Panel Insert Bulkhead Rear Mount TRB 3 Lug Isolated Bend Relief Spring Jack with 30-02002 Lead 12"	\$132.82
REF00235-12N	3 Jack Panel Insert Bulkhead Rear Mount TRB 3 Lug Isolated Jack with 30-02001 Lead 12"	\$139.90
REF00236-12N	3 Jack Panel Insert Bulkhead Rear Mount TRB 3 Lug Isolated Jack with 30-02003 Lead 12"	\$139.75
REF00237-12N	3 Jack Panel Insert Bulkhead Rear Mount TRB 3 Lug Isolated Jack with M17/176-00002 Lead 12"	\$146.35
REF00238-12N	3 Jack Panel Insert Bulkhead Rear Mount TRB 3 Lug Isolated Jack with 30-02002 Lead 12"	\$149.92
REF00239-12N	3 Jack Panel Insert Bulkhead Rear Mount TRB 3 Lug Isolated Bend Relief Spring Jack with 30-02001 Lead 12"	\$183.22

Universal Sub-Panels

Item #	Description	1 Pc. Price
REF00240-12N	3 Jack Panel Insert Bulkhead Rear Mount TRB 3 Lug Isolated Bend Relief Spring Jack with 30-02003 Lead 12"	\$183.07
REF00241-12N	3 Jack Panel Insert Bulkhead Rear Mount TRB 3 Lug Isolated Bend Relief Spring Jack with M17/176-00002 Lead 12"	\$189.67
REF00242-12N	3 Jack Panel Insert Bulkhead Rear Mount TRB 3 Lug Isolated Bend Relief Spring Jack with 30-02002 Lead 12"	\$193.24
REF00243-12N	4 Jack Panel Insert Bulkhead Rear Mount TRB 3 Lug Isolated Jack with 30-02001 Lead 12"	\$180.54
REF00244-12N	4 Jack Panel Insert Bulkhead Rear Mount TRB 3 Lug Isolated Jack with 30-02003 Lead 12"	\$180.34
REF00245-12N	4 Jack Panel Insert Bulkhead Rear Mount TRB 3 Lug Isolated Jack with M17/176-00002 Lead 12"	\$189.14
REF00246-12N	4 Jack Panel Insert Bulkhead Rear Mount TRB 3 Lug Isolated Jack with 30-02002 Lead 12"	\$193.90
REF00247-12N	4 Jack Panel Insert Bulkhead Rear Mount TRB 3 Lug Isolated Bend Relief Spring Jack with 30-02001 Lead 12"	\$238.30
REF00248-12N	4 Jack Panel Insert Bulkhead Rear Mount TRB 3 Lug Isolated Bend Relief Spring Jack with 30-02003 Lead 12"	\$238.10
REF00249-12N	4 Jack Panel Insert Bulkhead Rear Mount TRB 3 Lug Isolated Bend Relief Spring Jack with M17/176-00002 Lead 12"	\$246.90
REF00250-12N	4 Jack Panel Insert Bulkhead Rear Mount TRB 3 Lug Isolated Bend Relief Spring Jack with 30-02002 Lead 12"	\$251.66
REF00198-12N	3 Jack Panel Insert Bulkhead Rear Mount TRB 3 Lug Non Isolated Bend Relief Spring Jack with 30-02002 Lead 12"	\$292.16
REF00199-12N	4 Jack Panel Insert Bulkhead Rear Mount TRB 3 Lug Non Isolated Jack with 30-02001 Lead 12"	\$170.48
REF00200-12N	4 Jack Panel Insert Bulkhead Rear Mount TRB 3 Lug Non Isolated Jack with 30-02003 Lead 12"	\$170.27
REF00201-12N	4 Jack Panel Insert Bulkhead Rear Mount TRB 3 Lug Non Isolated Jack with M17/176-00002 Lead 12"	\$179.06
REF00202-12N	4 Jack Panel Insert Bulkhead Rear Mount TRB 3 Lug Non Isolated Jack with 30-02002 Lead 12"	\$176.81
REF00203-12N	4 Jack Panel Insert Bulkhead Rear Mount TRB 3 Lug Non Isolated Bend Relief Spring Jack with 30-02001 Lead 12"	\$371.87
REF00204-12N	4 Jack Panel Insert Bulkhead Rear Mount TRB 3 Lug Non Isolated Bend Relief Spring Jack with 30-02003 Lead 12"	\$371.67
REF00205-12N	4 Jack Panel Insert Bulkhead Rear Mount TRB 3 Lug Non Isolated Bend Relief Spring Jack with M17/176-00002 Lead 12"	\$399.97
REF00206-12N	4 Jack Panel Insert Bulkhead Rear Mount TRB 3 Lug Non Isolated Bend Relief Spring Jack with 30-02002 Lead 12"	\$385.21



Universal Sub-Panels

Item #	Description	1 Pc. Price
REF00010	Universal Sub-Panel with Two ECF Holes	\$7.90
REF00014	Universal Steel Sub-Panel with Four Keystone Openings	\$7.90
REF00015	Universal Steel Sub-Panel with One 0.5" D-Hole	\$6.76
REF00016	Universal Steel Sub-Panel with Two 0.5" D-Holes	\$6.76
REF00017	Universal Steel Sub-Panel with Three 0.5" D-Holes	\$6.76
REF00018	Universal Steel Sub-Panel with Four 0.5" D-Holes	\$6.76
REF00275	Universal Rack Mount Sub-Panel with 1 0.630" D-Hole	\$11.98
REF00276	Universal Rack Mount Sub-Panel with 2 0.630" D-Holes	\$11.98
REF00277	Universal Rack Mount Sub-Panel with 3 0.630" D-Holes	\$11.98
REF00278	Universal Rack Mount Sub-Panel with 4 0.630" D-Holes	\$11.98
REF00279	Universal Rack Mount Sub-Panel with 2 N-Type 50 Ohm Couplers installed	\$25.98
REF00280	Universal Rack Mount Sub-Panel with 3 N-Type 50 Ohm Couplers installed	\$30.98
REF00281	Universal Rack Mount Sub-Panel with 4 N-Type 50 Ohm Couplers installed	\$35.98
REF00003	Universal Sub-Panel, IEEE-488 Bulkhead Adapter, Normal Entry	\$45.23
REF00004	Universal Sub-Panel, IEEE-488 Bulkhead Adapter, Reverse Entry	\$45.23
REF00006	Universal Sub-Panel with Binding Post Pair	\$11.56
REF00007	Universal Sub-Panel, Two ECF504B-UAB Couplers	\$22.68
REF00008	Universal Sub-Panel, Two ECF504-UABS Couplers	\$24.95
REF00009	Universal Sub-Panel, Two ECF504B-94MS Couplers	\$30.63
REF00011	Universal Sub-Panel, 2 Shielded Category 6 Couplers, RJ45 Straight Thru	\$28.36
REF00012	Universal Sub-Panel, 4 Shielded Category 6 Couplers, RJ45 Straight Thru	\$16.66
REF00013	Universal Steel Sub-Panel with Two Keystone Openings	\$7.90
REF00019	Universal Sub-Panel, 2 BNC Feed-Thru Adapters	\$18.51
REF00020	Universal Sub-Panel, 4 BNC Feed-Thru Adapters	\$28.36
REF00021	Universal Sub-Panel, 2 Isolated BNC Feed-Thru Adapters	\$7.30
REF00022	Universal Sub-Panel, 4 Isolated BNC Feed-Thru Adapters	\$31.77
REF00023	Universal Sub-Panel, One N Type Feed-Thru Bulkhead Adapter	\$5.03
REF00024	Universal Sub-Panel, 2 TNC Feed-Thru Adapters, Non-Isolated	\$19.26
REF00025	Universal Sub-Panel, 2 TNC Feed-Thru Adapters, Isolated	\$21.53
REF00026	Universal Steel Sub-Panel with Two DB9/HD15 holes	\$7.90
REF00027	Universal Steel Sub-Panel with Two DB15/HD26 holes	\$7.90
REF00028	Universal Steel Sub-Panel with Two DB25/HD44 holes	\$7.90
REF00029	Universal Steel Sub-Panel with One DB37/HD62 hole	\$7.90
REF00030	Universal Sub-Panel, 2 DB9 Feed-Thru Adapters	\$20.40



REF00010



REF00014



REF00276



REF00278



REF00003



REF00006



REF00279



REF00281



REF00008



REF00011



REF00012



REF00019



REF00022



REF00023

Universal Sub-Panels

Item #	Description	1 Pc. Price
REF00031	Universal Sub-Panel, 2 HD15 Feed-Thru Adapters	\$26.64
REF00032	Universal Sub-Panel, 2 HD15 Feed-Thru Adapters	\$22.68
REF00033	Universal Sub-Panel, 2 HD26 Feed-Thru Adapters	\$29.48
REF00034	Universal Sub-Panel, 2 DB25 Feed-Thru Adapters	\$24.95
REF00035	Universal Sub-Panel, 2 HD44 Feed-Thru Adapters	\$32.90
REF00036	Universal Sub-Panel, One DB9 and One DB25 Feed-Thru	\$23.17
REF00037	Universal Sub-Panel, One DB37 Feed-Thru Adapter	\$18.13
REF00038	Universal Sub-Panel, Dual HDMI Couplers	\$34.04
REF00039	Universal Sub-Panel, Dual DVI Couplers	\$45.40
REF00040	Universal Sub-Panel, Dual XLR 3 Pin Male Couplers	\$17.00
REF00041	Universal Sub-Panel, Dual XLR 3 Pin Female Couplers	\$17.08
REF00042	Universal Sub-Panel, Dual XLR 3 Pin Couplers 1-M 1-F	\$17.00
REF00043	Universal Sub-Panel, Dual 3.5mm Stereo Audio Female Couplers	\$26.09
REF00044	Universal Sub-Panel, Quad 3.5mm Stereo Audio Female Couplers	\$17.22
REF00050	Universal Sub-Panel, Cable Minder Kit	\$21.53
REF00051	Universal Sub-Panel, 2 Simplex ST Couplers	\$19.26
REF00052	Universal Sub-Panel, 4 Simplex ST Couplers	\$24.95
REF00053	Universal Sub-Panel, 1 Singlemode or Multimode Duplex LC Coupler	\$21.53
REF00054	Universal Sub-Panel, 2 Multimode Quad LC Couplers	\$31.77
REF00055	Universal Sub-Panel, 2 Simplex APC FC Couplers	\$34.04
REF00056	Universal Sub-Panel, 4 Simplex APC FC Couplers	\$54.49
REF00057	Universal Sub-Panel, 1 Duplex APC SC Coupler	\$30.63
REF00058	Universal Sub-Panel, 2 Duplex APC SC Coupler	\$32.90
REF00207	1 Jack Panel Insert Bulkhead Front Mount TRB 3 Lug Isolated	\$45.88
REF00208	1 Jack Panel Insert Bulkhead Rear Mount TRB 3 Lug Isolated	\$45.58
REF00209	1 Jack Panel Insert Bulkhead Feed Through TRB 3 Lug Isolated	\$52.58
REF00210	2 Jack Panel Insert Bulkhead Front Mount TRB 3 Lug Isolated	\$77.68
REF00211	2 Jack Panel Insert Bulkhead Rear Mount TRB 3 Lug Isolated	\$76.98
REF00212	2 Jack Panel Insert Bulkhead Feed Through TRB 3 Lug Isolated	\$90.98
REF00213	3 Jack Panel Insert Bulkhead Front Mount TRB 3 Lug Isolated	\$110.58
REF00214	3 Jack Panel Insert Bulkhead Rear Mount TRB 3 Lug Isolated	\$109.58
REF00215	3 Jack Panel Insert Bulkhead Feed Through TRB 3 Lug Isolated	\$130.58
REF00216	4 Jack Panel Insert Bulkhead Front Mount TRB 3 Lug Isolated	\$143.58
REF00217	4 Jack Panel Insert Bulkhead Rear Mount TRB 3 Lug Isolated	\$141.98
REF00218	4 Jack Panel Insert Bulkhead Feed Through TRB 3 Lug Isolated	\$169.98



REF00031



REF00032



REF00036



REF00039



REF00042



REF00052



REF00053



REF00056



REF00057



REF00058



REF00207



REF00210



REF00213



REF00218

PATCH PANELS | Fiber Optic Rack Panels

Patch Panels suited for Military applications. Ethernet, Fiber Optic, USB, D-Sub, HDMI, GPIB. Suited for rugged environments, available in many different configurations to meet all applications and forms of connectivity. Custom panel identifiers and connector configurations available with quick turn.



Part #	1 Piece Price
REF00068	\$142.01
REF00069	\$187.48

Description
Universal Rack Panel with 12 Simplex ST Couplers
Universal Rack Panel with 24 Simplex ST Couplers



Part #	1 Piece Price
REF00065	\$236.34
REF00067	\$298.85

Description
3.50" Panel, 32 ST Bronze Couplers with Cable Minder
3.50" Panel, 32 ST Ceramic Couplers w/ Cable Minder



Part #	1 Piece Price
REF00059	\$174.98

Description
Universal Rack Panel with 6 Type N Couplers, 50 Ohm



Part #	1 Piece Price
REF00071	\$417.06
REF00073	\$442.06

Description
3.50" Panel, 32 FC Bronze Couplers with Cable Minder
3.50" Panel, 32 FC Ceramic Couplers w/ Cable Minder



Part #	1 Piece Price
REF00070	\$249.99
REF00074	\$335.23
REF00072	\$274.98

Description
1.75" Panel, 16 FC Bronze Couplers with Cable Minder
1.75" Panel, 16 FC APC Ceramic Couplers w/Cable Minder
1.75" Panel, 16 FC Ceramic Couplers with Cable Minder



Part #	1 Piece Price
REF00064	\$162.47
REF00066	\$199.13

Description
1.75" Panel, 16 ST Bronze Couplers with Cable Minder
1.75" Panel, 16 ST Ceramic Couplers with Cable Minder



Part #	1 Piece Price
REF00075	\$335.23
REF00076	\$397.73

Description
3.50" Panel, 32 Duplex SC Couplers Multimode
3.50" Panel, 32 Duplex SC Couplers Single Mode



Part #	1 Piece Price
REF00079	\$223.84
REF00080	\$131.78

Description
1.75" x 19" Patch Panel, 16 LC Singlemode Couplers
1.75" x 19" Patch Panel, 16 LC Multimode Couplers



Part #	1 Piece Price
REF00085	\$248.85

Description
19" Rack Panel with 16 MPO Fiber Optic Couplers - 1U High



Part #	1 Piece Price
REF00077	\$162.47
REF00078	\$187.48

Description
Universal Rack Panel with 6 Duplex SC Couplers
Universal Rack Panel with 12 Duplex SC Couplers



Part #	1 Piece Price
REF00081	\$323.86
REF00082	\$611.41

Description
Rack Panel, 96 LC Couplers Multimode-Bronze Sleeves
Rack Panel, 96 LC Couplers Single mode-Ceramic Sleeves



Part #	1 Piece Price
REF00083	\$254.20
REF00084	\$415.58

Description
1.75" x 19" Patch Panel, with 24 LC Multimode Couplers
1.75" x 19" Patch Panel with 24 LC Singlemode Couplers



Part #	1 Piece Price
REF00087	\$32.87
REF00088	\$47.68
Description	
1.75" Panel, 16 0.5" D-Holes	
1.75" Panel, 16 0.5" D-Holes with Cable Minder	



Part #	1 Piece Price
REF00089	\$37.45
REF00090	\$62.45
Description	
3.50" Panel, 32 0.5" D-Holes	
3.50" Panel, 32 0.5" D-Holes with Cable Minder	



Part #	1 Piece Price
REF00093	\$149.97
Description	
1.75" Panel, 16 BNC Adapters Isolated with Cable Minder	



Part #	1 Piece Price
REF00092	\$224.98
REF00096	\$262.50
Description	
3.50" Panel, 32 BNC Adapters Isolated	
3.50" Panel, 32 75 Ohm BNC Adapters Isolated	



Part #	1 Piece Price
REF00094	\$249.99
Description	
3.50" Panel, 32 BNC Adapters Isolated with Cable Minder	



Part #	1 Piece Price
REF00091	\$124.97
REF00095	\$137.47
Description	
1.75" Panel, 16 BNC Adapters Isolated	
1.75" Panel, 16 75 Ohm BNC Adapters Isolated	



Part #	1 Piece Price
REF00251	\$481.39
REF00252	\$606.43
Description	
1.75" (1U) 16 Port Jack Panel Insert Bulkhead Rear Mount TRB 3 Lug Non-Isolated	
1.75" (1U) 16 Port Jack Panel Insert Bulkhead Rear Mount TRB 4 Lug Non-Isolated	



Part #	1 Piece Price
REF00253	\$606.43
REF00254	\$606.43
Description	
1.75" (1U) 16 Port Jack Panel Insert Bulkhead Rear Mount TRB 2 Lug Non-Isolated	
1.75" (1U) 16 Port Jack Panel Insert Bulkhead Rear Mount TRT Threaded Non-Isolated	



Part #	1 Piece Price
REF00255	\$634.77
REF00256	\$689.79
REF00257	\$689.79
Description	
1.75" (1U) 16 Port Jack Panel Insert Bulkhead Feed Through TRB 3 Lug Non-Isolated	
1.75" (1U) 16 Port Jack Panel Insert Bulkhead Feed Through TRB 2 Lug Non-Isolated	
1.75" (1U) 16 Port Jack Panel Insert Bulkhead Feed Through TRT Threaded Non-Isolated	



Part #	1 Piece Price
REF00258	\$940.91
REF00259	\$1190.99
Description	
3.5" (2U) 32 Port Jack Panel Insert Bulkhead Rear Mount TRB 3 Lug Non-Isolated	
3.5" (2U) 32 Port Jack Panel Insert Bulkhead Rear Mount TRB 4 Lug Non-Isolated	



Part #	1 Piece Price
REF00260	\$1190.99
REF00261	\$1190.99
Description	
3.5" (2U) 32 Port Jack Panel Insert Bulkhead Rear Mount TRB 2 Lug Non-Isolated	
3.5" (2U) 32 Port Jack Panel Insert Bulkhead Rear Mount TRT Threaded Non-Isolated	



Part #	1 Piece Price
REF00262	\$1247.67
REF00263	\$1357.71
REF00264	\$1357.71
Description	
3.5" (2U) 32 Port Jack Panel Insert Bulkhead Feed Through TRB 3 Lug Non-Isolated	
3.5" (2U) 32 Port Jack Panel Insert Bulkhead Feed Through TRB 2 Lug Non-Isolated	
3.5" (2U) 32 Port Jack Panel Insert Bulkhead Feed Through TRT Threaded Non-Isolated	

PATCH PANELS | Coaxial/Twinaxial/Triaxial Rack Panels

Our Patch Panels are designed for Military applications. USB, D-Sub, HDMI® and Ethernet versions are suited for rugged environments and are available in many different configurations to meet all applications and forms of connectivity. Custom panel identifiers and connector options are also available with quick turn.



Part #	1 Piece Price
REF00265	\$574.26

Description
1.75" (1U) 16 Port Jack Panel Insert Bulkhead Front Mount TRB 3 Lug Isolated



Part #	1 Piece Price
REF00266	\$574.26

Description
1.75" (1U) 16 Port Jack Panel Insert Bulkhead Rear Mount TRB 3 Lug Isolated



Part #	1 Piece Price
REF00267	\$690.58

Description
1.75" Blank Rack Panel Accepts 16 Flange Style Couplers



Part #	1 Piece Price
REF00268	\$1135.46

Description
3.5" (2U) 32 Port Jack Panel Insert Bulkhead Front Mount TRB 3 Lug Isolated



Part #	1 Piece Price
REF00269	\$1125.54

Description
3.5" (2U) 32 Port Jack Panel Insert Bulkhead Rear Mount TRB 3 Lug Isolated



Part #	1 Piece Price
REF00270	\$1358.18

Description
3.5" (2U) 32 Port Jack Panel Insert Bulkhead Feed Through TRB 3 Lug Isolated



Part #	1 Piece Price
REF00271	\$28.98

Description
1.75" (1U) Panel with 16 0.630" D-Holes



Part #	1 Piece Price
REF00272	\$34.98

Description
3.5" (2U) Panel with 32 0.630" D-Holes



Part #	1 Piece Price
REF00273	\$114.98

Description
1.75" (1U) Panel with 16 N-Type 50 Ohm Couplers Installed



Part #	1 Piece Price
REF00274	\$204.98

Description
3.5" (2U) Panel with 32 N-Type 50 Ohm Couplers Installed



Part #	1 Piece Price
REF00282	\$58.98

Description
1.75" (1U) Panel with 16 0.630" D-Holes, Includes Cable Management Brackets



Part #	1 Piece Price
REF00283	\$64.98

Description
3.5" (2U) Panel with 32 0.630" D-Holes, Includes Cable Management Brackets



Part #	1 Piece Price
REF00284	\$144.98

Description
1.75" (1U) Panel with 16 N-Type 50 Ohm Couplers & Cable Management Brackets Installed



Part #	1 Piece Price
REF00285	\$234.98

Description
3.5" (2U) Panel with 32 N-Type 50 Ohm Couplers & Cable Management Brackets Installed

Ethernet Rack Panels | PATCH PANELS



Part #	1 Piece Price
REF00126	\$49.96
Description	1.75" Blank Rack Panel Accepts 16 Flange Style Couplers



Part #	1 Piece Price
REF00138	\$37.45
Description	1.75" Blank Panel Accepts 16 Keystone Couplers



Part #	1 Piece Price
REF00127	\$63.60
Description	3.50" Blank Rack Panel Accepts 32 Couplers



Part #	1 Piece Price
REF00139	\$49.96
Description	3.50" Blank Panel Accepts 32 Keystone Couplers



Part #	1 Piece Price
REF00118	\$211.73
Description	1.75" 16 Port Flange Style Mounted Category 5e Feed-Thru Panel, Unshielded



Part #	1 Piece Price
REF00119	\$287.48
Description	1.75" 16 Port Flange Style Mounted Category 5e Feed-Thru Panel, Shielded



Part #	1 Piece Price
REF00120	\$249.99
Description	1.75" 16 Port Flange Style Mounted Category 6 Feed-Thru Panel, Unshielded



Part #	1 Piece Price
REF00121	\$317.98
Description	1.75" 16 Port Flange Style Mounted Category 6 Feed-Thru Panel, Shielded



Part #	1 Piece Price
REF00130	\$232.93
Description	Universal Sub-Panel, Steel 3.5" x 19" Universal Master Rack Panel



Part #	1 Piece Price
REF00131	\$278.40
Description	1.75" 16 Port Low Profile Offset Category 5e Feed-Thru Panel, Shielded

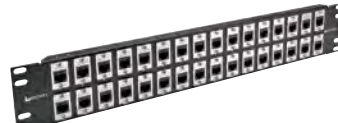

Part #	1 Piece Price
REF00122	\$400.01
Description	3.50" 32 Port Flange Style Mounted Category 5e Feed-Thru Panel, Unshielded



Part #	1 Piece Price
REF00123	\$500.02
Description	3.50" 32 Port Flange Style Mounted Category 5e Feed-Thru Panel, Shielded



Part #	1 Piece Price
REF00124	\$437.51
Description	3.50" 32 Port Flange Style Mounted Category 6 Feed-Thru Panel, Unshielded



Part #	1 Piece Price
REF00125	\$537.53
Description	3.50" 32 Port Flange Style Mounted Category 6 Feed-Thru Panel, Shielded



Part #	1 Piece Price
REF00134	\$237.49
Description	1.75" 16 Port Low Profile Category 6 Feed-Thru Panel, Unshielded



Part #	1 Piece Price
REF00135	\$299.99
Description	1.75" 16 Port Low Profile Category 6 Feed-Thru Panel, Shielded



Part #	1 Piece Price
REF00132	\$392.05
Description	3.50" 32 Port Low Profile Offset Cat5e Feed-Thru Panel, Unshielded



Part #	1 Piece Price
REF00133	\$454.56
Description	3.50" 32 Port Low Profile Offset Cat5e Feed-Thru Panel, Shielded



Part #	1 Piece Price
REF00137	\$462.52
Description	3.50" 32 Port Low Profile Category 6 Feed-Thru Panel, Shielded



Part #	1 Piece Price
REF00136	\$400.01
Description	3.50" 32 Port Low Profile Category 6 Feed-Thru Panel, Unshielded

PATCH PANELS | USB, D-Sub, DVI & HDMI® Rack Panels



Part #	1 Piece Price
REF00103	\$67.00
Description	
1.75" X 19" Blank Panel with 16 Universal DB9 / HD15 / HDMI Cutouts	

Part #	1 Piece Price
REF00104	\$70.41
Description	
3.5" X 19" Blank Panel with 32 Universal DB9 / HD15 / HDMI Cutouts	

Part #	1 Piece Price
REF00105	\$37.45
Description	
3.5" X 19" Blank Panel with 16 Universal DB15 / HD26 / DVI DisplayPort Cutouts	

Part #	1 Piece Price
REF00106	\$35.58
Description	
3.5" X 19" Blank Panel with 16 Universal DB25 / HD44 Cutouts	



Part #	1 Piece Price
REF00107	\$74.96
Description	
3.5" X 19" Blank Panel with 16 Universal DB37 / HD62 Cutouts	

Part #	1 Piece Price
REF00099	\$198.84
Description	
3.50" x 19" Panel, 16 DVI Female / Female Couplers	

Part #	1 Piece Price
REF00097	\$248.85
Description	
1.75" x 19" HDMI Patch Panel, 16 HDMI Female / Female Couplers	

Part #	1 Piece Price
REF00098	\$373.31
Description	
3.50" x 19" HDMI Patch Panel, 32 HDMI Female / Female Couplers	



Part #	1 Piece Price
REF00101	\$162.47
Description	
1.75" 16 Port Panel USB A/B Flanged Coupler, Shielded	

Part #	1 Piece Price
REF00102	\$287.48
Description	
3.50" 32 Port Panel USB A/B Flanged Coupler, Shielded	

Part #	1 Piece Price
REF00100	\$149.97
Description	
1.75" 16 Port Panel USB A/B Flanged Coupler	

Part #	1 Piece Price
REF00108	\$144.28
Description	
1.75" x 19" Panels with 16 DB9 Female / Female Couplers	

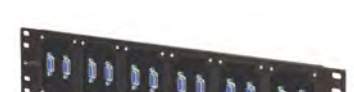

Part #	1 Piece Price
REF00109	\$223.84
Description	
3.5" x 19" Panels with 32 DB9 Female / Female Couplers	

Part #	1 Piece Price
REF00110	\$149.97
Description	
Universal Rack Panel with 12 DB9 Female / Female	

Part #	1 Piece Price
REF00111	\$156.78
Description	
1.75" x 19" Panel, 16 HD15 Female / Female SVGA Couplers	

Part #	1 Piece Price
REF00112	\$244.30
Description	
3.50" x 19" Panel, 32 HD15 Female / Female SVGA Couplers	



Part #	1 Piece Price
REF00113	\$156.78
Description	
3.50" x 19" Panel, 16 DB15 Female / Female Couplers	

Part #	1 Piece Price
REF00114	\$174.98
Description	
3.50" x 19" Panel, 16 DB25 Female / Female Couplers	

Part #	1 Piece Price
REF00115	\$215.89
Description	
3.50" x 19" Panel, 16 DB37 Female / Female Couplers	

LSZH and Locking Power Cords

Item #	Description	1 Pc. Price
REF00061	N5-15 to C13 LSZH Power Cords 14AWG 2 Meters	\$24.73
REF00143	N5-15 to C13 LSZH Power Cords 14AWG 3 Meters	\$28.14
REF00060	N5-15 to C13 LSZH Power Cords 16AWG 2 Meters	\$18.55
REF00144	N5-15 to C13 LSZH Power Cords 16AWG 3 Meters	\$20.59
REF00145	N5-15 to C13 LSZH Power Cords 18AWG 2 Meters	\$15.74
REF00146	N5-15 to C13 LSZH Power Cords 18AWG 3 Meters	\$19.55
REF00063	Locking C13 to BS1363 Power Cord 2 Meters	\$15.27



Power Cords

Item #	Description	1 Pc. Price
MPPA00002-01F	Heavy Duty CPU/PDU Power Cord - C14 to C13 - 15 A, 1ft	\$5.85
MPPA00002-02F	Heavy Duty CPU/PDU Power Cord - C14 to C13 - 15 A, 2ft	\$7.35
MPPA00002-03F	Heavy Duty CPU/PDU Power Cord - C14 to C13 - 15 A, 3ft	\$9.60
MPPA00002-06F	Heavy Duty CPU/PDU Power Cord - C14 to C13 - 15 A, 6ft	\$14.45
MPPA00002-08F	Heavy Duty CPU/PDU Power Cord - C14 to C13 - 15 A, 8ft	\$15.87
MPPA00002-12F	Heavy Duty CPU/PDU Power Cord - C14 to C13 - 15 A, 12ft	\$19.95
MPPA00002-25F	Heavy Duty CPU/PDU Power Cord - C14 to C13 - 15 A, 25ft	\$33.25
MPPA00005-01F	High Temperature Power Cord - C14 to C15 - 15 Amp, 1ft	\$5.75
MPPA00005-02F	High Temperature Power Cord - C14 to C15 - 15 Amp, 2ft	\$7.50
MPPA00005-03F	High Temperature Power Cord - C14 to C15 - 15 Amp, 3ft	\$8.40
MPPA00005-06F	High Temperature Power Cord - C14 to C15 - 15 Amp, 6ft	\$13.70
MPPA00005-08F	High Temperature Power Cord - C14 to C15 - 15 Amp, 8ft	\$16.40
MPPA00005-25F	High Temperature Power Cord - C14 to C15 - 15 Amp, 25ft	\$34.10
MPPA00006-03F	Server/PDU Power Cord - C14 to C19 - 15 Amp, 3ft	\$9.70
MPPA00006-06F	Server/PDU Power Cord - C14 to C19 - 15 Amp, 6ft	\$15.10
MPPA00007-06F	PC/PDU Power Cord - C20 to C13 - 15 Amp - Black, 6ft	\$14.00
MPPA00008-01F	Server/PDU Power Cord - C20 to C19 - 20 A - Black, 1ft	\$9.35
MPPA00008-02F	Server/PDU Power Cord - C20 to C19 - 20 A - Black, 2ft	\$10.50
MPPA00008-03F	Server/PDU Power Cord - C20 to C19 - 20 A - Black, 3ft	\$12.00
MPPA00008-06F	Server/PDU Power Cord - C20 to C19 - 20 A - Black, 6ft	\$12.70
MPPA00008-08F	Server/PDU Power Cord - C20 to C19 - 20 A - Black, 8ft	\$23.00
MPPA00008-10F	Server/PDU Power Cord - C20 to C19 - 20 A - Black, 10ft	\$27.75
MPPA00008-15F	Server/PDU Power Cord - C20 to C19 - 20 A - Black, 15ft	\$33.60
MPPA00008-25F	Server/PDU Power Cord - C20 to C19 - 20 A - Black, 25ft	\$51.30
MPPA00009-04F	Laptop Power Cord - NEMA 5-15P to C5 - 10 Amp, 4ft	\$10.25
MPPA00009-06F	Laptop Power Cord - NEMA 5-15P to C5 - 10 Amp, 6ft	\$6.40
MPPA00009-10F	Laptop Power Cord - NEMA 5-15P to C5 - 10 Amp, 10ft	\$13.70
MPPA00009-15F	Laptop Power Cord - NEMA 5-15P to C5 - 10 Amp, 15ft	\$14.45
MPPA00011-01F	Universal CPU Power Cord - Nema 5-15P to C13, 1ft	\$4.35
MPPA00011-02F	Universal CPU Power Cord - Nema 5-15P to C13, 2ft	\$6.40
MPPA00011-03F	Universal CPU Power Cord - Nema 5-15P to C13, 3ft	\$7.45
MPPA00011-06F	Universal CPU Power Cord - Nema 5-15P to C13, 6ft	\$13.25
MPPA00011-08F	Universal CPU Power Cord - Nema 5-15P to C13, 8ft	\$15.80
MPPA00011-15F	Universal CPU Power Cord - Nema 5-15P to C13, 15ft	\$23.40
MPPA00011-25F	Universal CPU Power Cord - Nema 5-15P to C13, 25ft	\$33.90
MPPA00012-01F	Server Power Cord - NEMA 5-15P to C19 - 15 Amp, 1ft	\$6.45
MPPA00012-02F	Server Power Cord - NEMA 5-15P to C19 - 15 Amp, 2ft	\$7.45
MPPA00012-03F	Server Power Cord - NEMA 5-15P to C19 - 15 Amp, 3ft	\$9.60
MPPA00012-06F	Server Power Cord - NEMA 5-15P to C19 - 15 Amp, 6ft	\$13.45
MPPA00012-10F	Server Power Cord - NEMA 5-15P to C19 - 15 Amp, 10ft	\$20.65
MPPA00012-15F	Server Power Cord - NEMA 5-15P to C19 - 15 Amp, 15ft	\$25.75
MPPA00012-25F	Server Power Cord - NEMA 5-15P to C19 - 15 Amp, 25ft	\$30.17
MPPA00014-01F	PC/PDU Power Cord - NEMA 5-15 to C15 - 15 Amp, 1ft	\$8.50
MPPA00014-03F	PC/PDU Power Cord - NEMA 5-15 to C15 - 15 Amp, 3ft	\$13.35
MPPA00014-06F	PC/PDU Power Cord - NEMA 5-15 to C15 - 15 Amp, 6ft	\$16.60
MPPA00014-10F	PC/PDU Power Cord - NEMA 5-15 to C15 - 15 Amp, 10ft	\$23.40
MPPA00014-15F	PC/PDU Power Cord - NEMA 5-15 to C15 - 15 Amp, 15ft	\$39.45

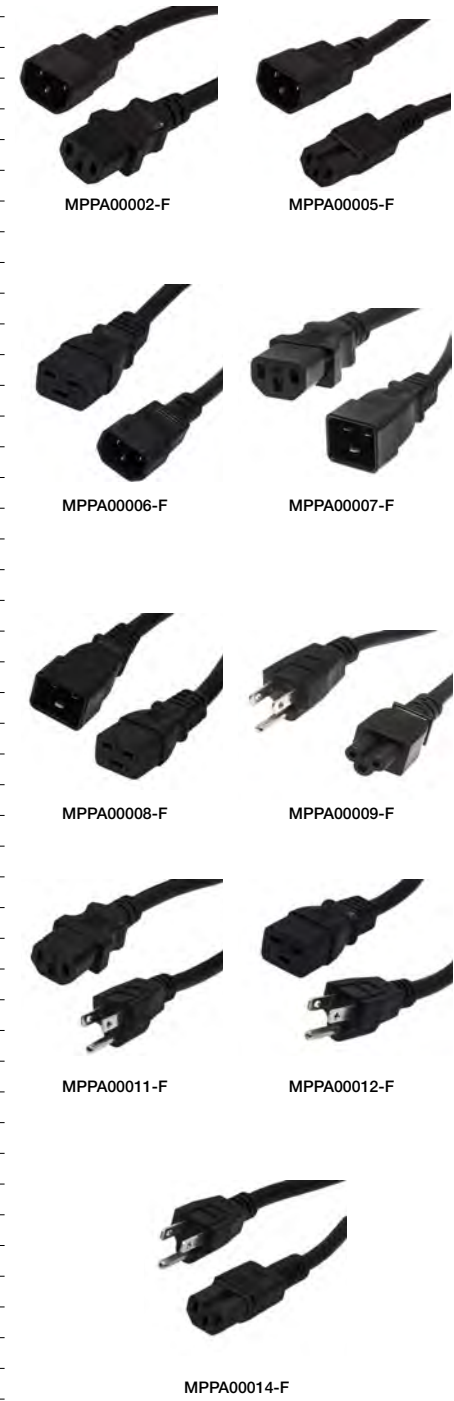

REFERENCE | Terms & Conditions

1. SCOPE; CHANGES

The terms and conditions stated herein (this "Agreement") govern all sales of products or services ("products") by Infinite Electronics, Inc. (collectively, "we," "us," "our," or "seller") to you or the entity you represent ("you" or "buyer"). You represent to us that you are lawfully able to enter into contracts (e.g., you are not a minor) and that if you are entering into this Agreement for an entity, such as the company you work for, you represent to us that you have the legal authority to bind that entity. Unless otherwise agreed to in writing by seller's authorized agent, any terms and conditions contained in buyer's purchase order or any other document that are different from or in addition to these terms and conditions are objected to, are rejected, and will not be binding on us. By placing an order for products from us, or by accepting delivery of the products described on the applicable packing slip, bill of lading and/or invoice received with the products, you agree to be bound by and accept these terms and conditions of sale.

We may change the terms and conditions of this Agreement in our sole discretion by posting an updated version of these terms and conditions at this location; provided, however, that the terms and condition of this Agreement in effect as of the date of an applicable order shall continue to govern such order and the products purchased thereunder.

2. ORDER ACCEPTANCE

- Your receipt of an email or other form of order confirmation does not constitute our acceptance of your order or a confirmation of an offer to sell.
- We reserve the right, without prior notification, to limit the order quantity on any item and/or refuse service to anyone.
- All orders are subject to review and acceptance by us. You agree to provide complete and accurate contact information in connection with any order submitted to us. Verification of information may be required prior to the acceptance of any order.
- In the case of pre-stocked finished goods, order acceptance is designated by fulfilling the order. In the case of products requiring post-order processing (including but not limited to design, material purchase, manufacturing or test), order acceptance is designated by performing activities unique to the order.

3. ORDER CANCELLATION

- Orders fully or partially processed by seller may not be cancelled by buyer.
- Products not previously stocked as finished goods are both Non-Cancelable and Non-Refundable ("NC/NR"). NC/NR products include cable assemblies, special orders, custom orders, orders for non-standard products, products not customarily in stock, scheduled orders requiring special procurements, or orders for products requiring assembly or manufacturing activities prior to shipping (not stored in completed state) as well as purchased services such as special testing or product modifications.
- In the event of cancellation or other withdrawal of an order for any reason and without limiting any other remedy as a result of such cancellation or other withdrawal, reasonable cancellation or restocking charges, which shall include all expenses then incurred and commitments made by seller, shall be paid by buyer. Buyer's requests to reschedule are subject to acceptance by seller in its sole discretion. Orders may not be rescheduled after the order has been submitted by seller to the shipment carrier.

4. PRICES

- Orders are billed at the prices (in US dollars) in effect at the time of shipment.
- Prices will be as specified within seller's website or as stated in seller's quote / proposal. If no period is specified, quoted prices will be applicable for thirty (30) days.
- For catalog products, the website contains the most current catalog pricing and is the price reference for such orders. Pricing included in the catalog is for reference only and final pricing is determined by the published website price.
- For non-catalog products and services, prices cited are based on current costs and are subject to reasonable adjustment on or after the date of acceptance of any purchase order to meet a rise or fall in such costs, as computed on the date of delivery.
- Prices are subject to change without notice.
- Prices are exclusive of taxes, impositions and other charges, including: sales, use, excise, value added and similar taxes or charges imposed by any government authority, international shipping charges, forwarding agent's and broker's fees, bank fees, consular fees, document fees and import duties.

5. TERMS OF PAYMENT

- All payments must be in US Dollars, or will be converted to US Dollars using seller's standard exchange rate at the time of purchase.
- MasterCard, VISA and American Express credit cards, purchase cards and major bank debit cards are accepted. Payment via net thirty (30) days is available to businesses, schools and agencies or as otherwise specified by seller subject to credit approval.
- For International Orders, MasterCard, VISA, and American Express credit cards are accepted. Payment via open credit account with Net thirty (30) days may be established for companies having three U.S. references accepted to seller. Prepaid Wire Transfer: You can wire the funds

to our bank. We will contact you with the total amount, which will include shipping charges and a \$40 wire transfer fee. Orders will not be accepted until funds have been received in full and the Purchase Order (PO) has been received. Notwithstanding anything to the contrary in this Agreement, seller may add or remove payment options in seller's sole discretion.

- Buyer acknowledges that seller has the right to reassess buyer's creditworthiness from time to time. To the extent such is in accordance with law, in the event there is a decline in buyer's creditworthiness, seller may, upon thirty (30) days written notice, revise the payment terms between the parties. Upon request, buyer shall provide financial data evidencing the buyer's worth in order for seller to determine the creditworthiness of buyer. Such information shall include, but not be limited to, annual reports, balance sheets, and bank records.
- If buyer is delinquent in its payment obligations, without prejudice to any other remedies available to it by law or in equity, seller may demand immediate payment and at seller's option:
 - suspend all further deliveries to be made under the purchase order or any further performance under any other contract with buyer or buyer's affiliates, in which event buyer shall not be released in any respect from its obligations to seller under the purchase order;
 - recover all costs of collection including but not limited to reasonable attorneys' fees;
 - repossess the product for which payment has not been made;
 - charge interest at 1.5% per month on the past due amount, not to exceed the interest percentage allowed by law; and
 - reassess the credit worthiness of buyer and change any current payment terms. Any discount from seller's rates, if any, shall cease to apply to the delinquent invoice, buyer shall be invoiced for such differences in cost, and shall immediately pay the resulting invoice.

6. TAXES AND DUTIES

- Any taxes related to the products purchased are the responsibility of buyer (excluding taxes based on seller's net income), unless buyer presents an exemption certificate acceptable to seller and the applicable taxing authorities. If any exemption certificate presented by buyer is held to be invalid, then buyer will pay seller the amount of the tax and any penalties and interest related thereto.
- If possible, seller will bill taxes as a separate item on the invoice presented to buyer.
- Sales tax will be charged on product cost and shipping & handling where applicable and required by law. Any sales tax due that is not collected by the seller is the responsibility of the buyer.
- International orders may be subject to various taxes and duties in the country of destination, all of which are the responsibility of the buyer. This includes sales, use, excise, value added and similar taxes or charges imposed by any government authority, international shipping charges, forwarding agent's and broker's fees, bank fees, consular fees, document fees and import duties.

7. SHIPPING COSTS

Shipping or freight charges and insurance will be paid by the buyer and added to the invoice or billed collect unless specifically stated in the quote or order confirmation based on seller practices or promotions.

8. DELIVERY AND TITLE

- Unless otherwise agreed to in writing, all products are shipped Incoterms 2010 - FCA Shipping Point. Subject to seller's right of stoppage in transit, delivery of the products to the carrier will constitute delivery to buyer and title and risk of loss will pass to buyer.
- Seller will make reasonable efforts to initiate shipment and schedule delivery as close as possible to buyer's requested delivery date(s). Buyer acknowledges that delivery dates provided by seller are estimates only and that seller will not be liable for failure to deliver on such dates.
- Selection of the carrier and delivery route will be made by seller unless specifically designated by buyer.
- Seller reserves the right to make deliveries in installments. Delay in delivery of one installment will not entitle buyer to cancel any other installment(s). Delivery of any installment of products within thirty (30) days after the date requested will constitute a timely delivery. Delivery of a quantity that varies from the quantity specified shall not relieve buyer of the obligation to accept delivery and pay for the products delivered.
- Deliveries shall be made during normal business hours Monday through Friday. One attempt to deliver will be made. Should delivery need to be rescheduled, any additional costs incurred for redelivery and/or storage fees will be charged to the buyer. Seller shall use reasonable efforts to make timely delivery but shall be excused from any delays arising out of causes beyond its reasonable control. Any specific delivery dates that may be stated are approximate.
- If completion of delivery is prevented through no fault of seller, seller may specify a reasonable alternative place of delivery. Buyer agrees that all costs of storage and transport incurred following an initial attempt at delivery are hereby allocated to and imposed upon buyer, and shall be added by seller to the sale price. Delivery may at any time be withheld by seller pending payment of any sum due from the buyer to seller. Seller will return Product via the incoming method unless an alternative method has been indicated on the purchase order or a change authorized by the buyer representative.
- Deliveries made outside the 48 contiguous States may be subject to modified terms and conditions as stated within the order quote.

MilesTek, an Infinite Electronics brand



Infinite Electronics: A Portfolio of Companies Dedicated to Serving the Engineers' Urgent Needs

Each Infinite company is a specialist within their respective product set, offering broad inventories of engineering-grade product, paired with expert technical support and short lead times.

Brands



Products

Radio Frequency

Comprehensive and continuously expanding portfolio of radio frequency, microwave and millimeter products including interconnects, passives components and active components.

Wireless Connectivity

Full suite of passive WiFi and RFID products primarily used for wireless communications that include antennas, radios, surge protectors, cellular amplifiers and more.

Wired Connectivity

Diverse offering of standard, unique and custom products across the spectrum of connectors, cable assemblies, adapters and contact insertion/removal tools.

Industrial Networking

Network equipment, conversion equipment, power products and test related products with a focus on harsh environments and factory automation.

Applications

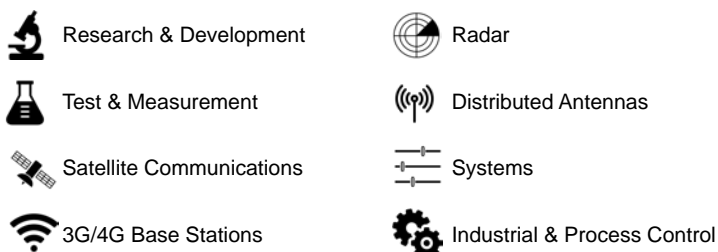

Markets

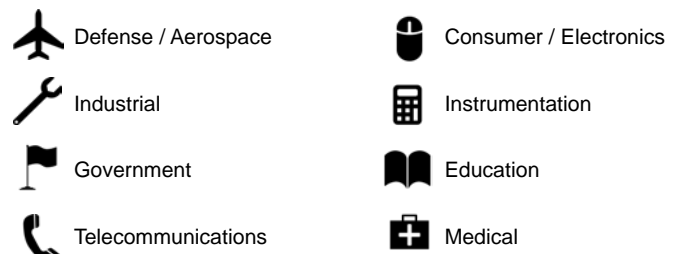

CONTACT ID:

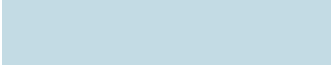

Our Experts are Here to Help:



Same-Day Shipping

On orders placed by 5:00 PM CT



Secure Online Ordering

milestek.com
sales@milestek.com



Toll Free +1 (866) 524-1553

Phone +1 (940) 484-9400



ISO 9001:2015

